





Hino[®]

LL1570/1H313200

-  Catalogo ricambi
-  Spare parts catalogue
-  Catalogue pièces détachées
-  Ersatzteilkatalog
-  Catálogo repuestos

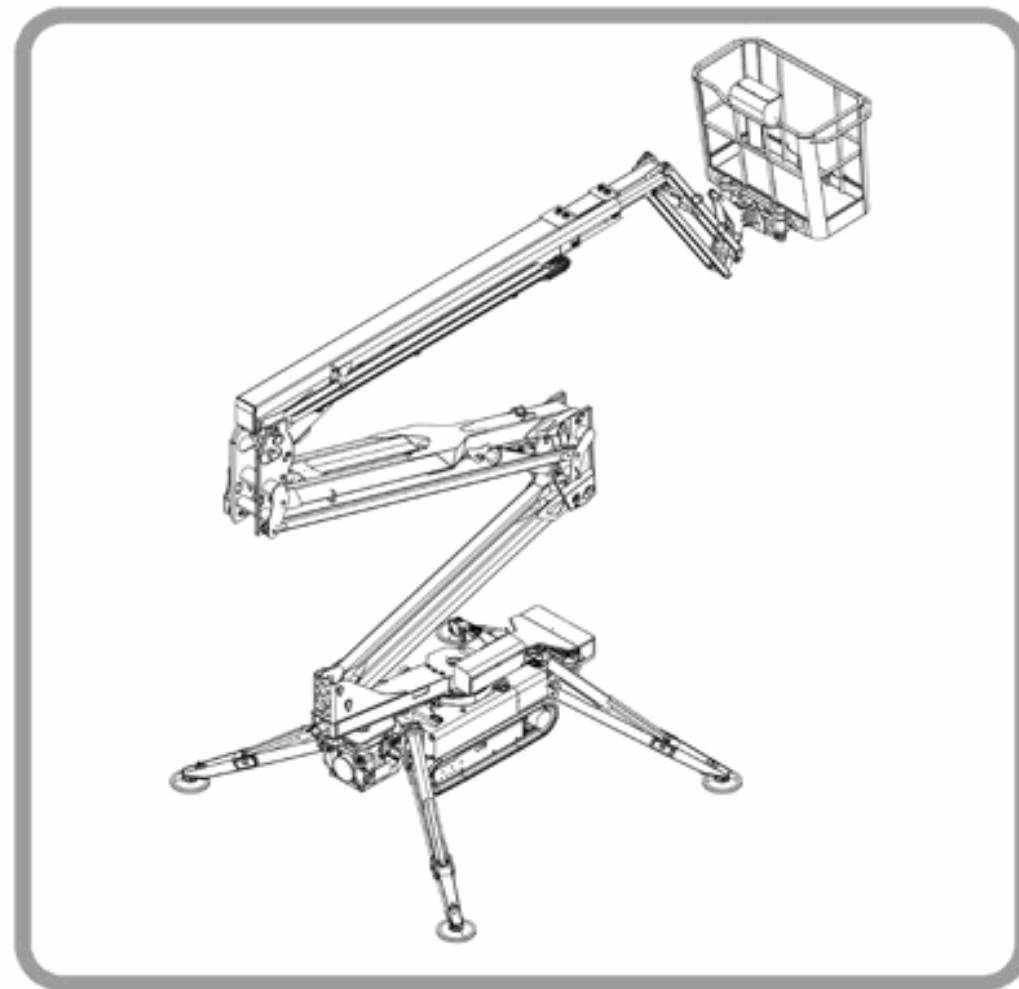

20171130

 SOTTOCARRO CINGOLATO

 TRACKED UNDERCARRIAGE

 CHENILLARD

RAUPENFAHRWERK 



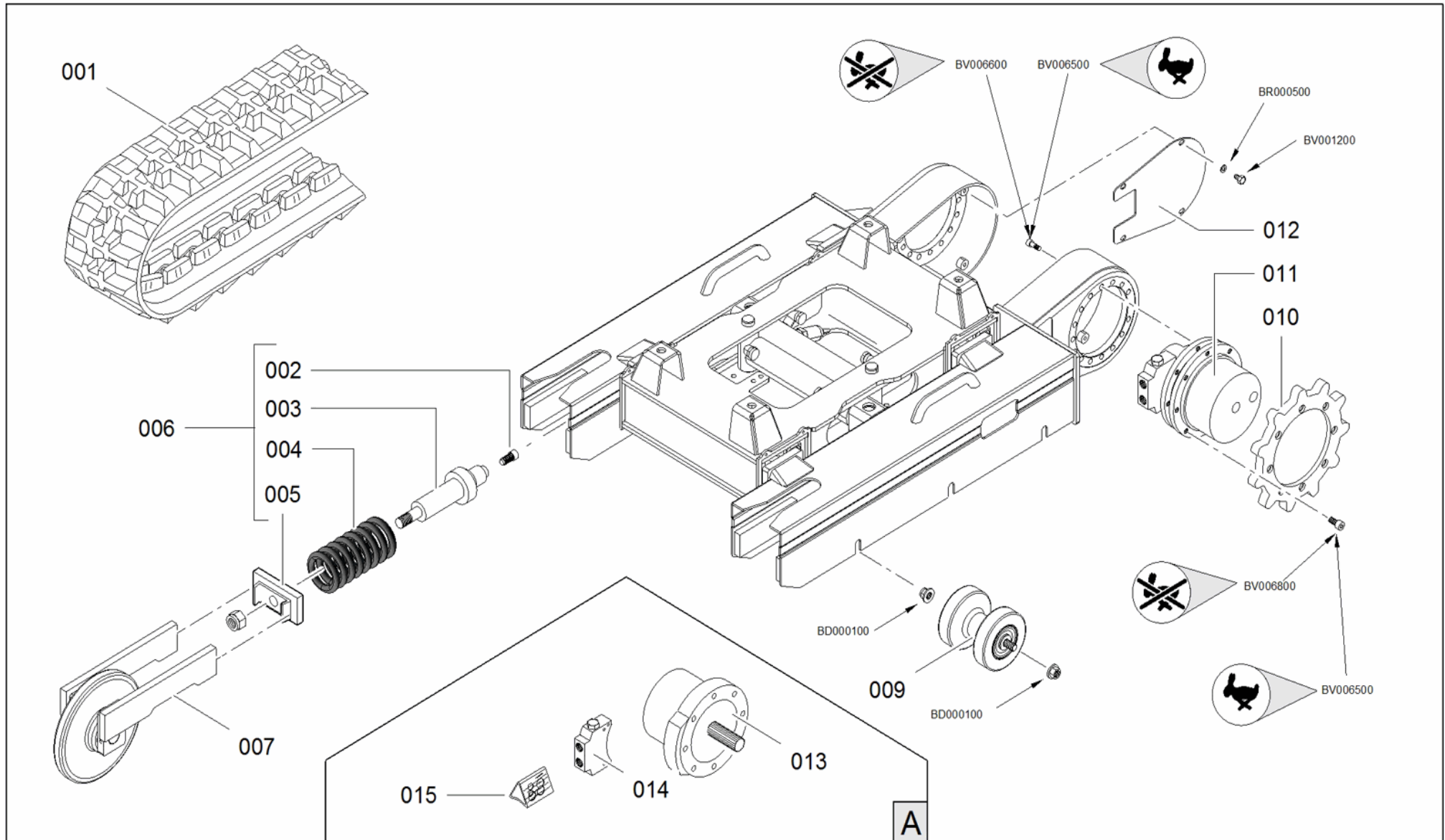

CARRO DE ORUGAS 



 SOTTOCARRO CINGOLATO

 RAUPENFAHRWERK 
 TRACKED UNDERCARRIAGE





 CARRO DE ORUGAS 
 CHENILLARD

POS Codice	Q.tà	 Descrizione	 Description	 Designation	 Benennung	 Descripción
1 053715L0	2 NR	CINGOLO IN GOMMA BASSO PROFILO NERO	RUBBER TRACK LOW PROFILE BLACK	CHENILLE EN CAOUTCHOUC	GUMMIRAUPE	ORUGA DE GOMA
2 03149200	1 NR	VALVOLA IDRAULICA	HYDRAULIC VALVE	VALVE HYDRAULIQUE	HYDRAULIKVENTIL	VÁLVULA HIDRÁULICA
3 10681670	1 NR	CILINDRO	CYLINDER	VÉRIN	ZYLINDER	CILINDRO
4 03024800	1 NR	MOLLA	SPRING	RESSORT	FEDER	MUELLE
5 34719500	1 NR	PIATTO	PLATE	PLATEAU	PLATTE	PLACA
6 147534Y1	2 NR	SUPPORTO TENDICINGOLO	IDLER SUPPORT	SUPPORT TENDEUR CHENILLE	KETTEHSPANNE R-HALTER	SOPORTE TENSOR ORUGA
7 153937H2	2 NR	RUOTA TENDICINGOLO	IDLER WHEEL	ROUE TENDEUR DE CHENILLE	RAUPENSPANNRAD	RUEDA TENSOR ORUGA
9 153515H2	6 NR	RULLO INFERIORE	CARRIER ROLLER	ROULEAU INFÉRIEUR	UNTERE ROLLE	RODILLO INFERIOR
10 041736H2	2 NR	RUOTA DI TRAZIONE	SPROCKET WHEEL	ROUE DE TRACTION	ANTRIEBSRAD	RUEDA DE ARRASTRE
11 147411H2	2 NR	MOTORIDUTTORE	MOTORGearBOX	MOTORÉDUCTEUR	GETRIEBEMOTOR	MOTORREDUCTOR
12 053809H2	2 NR	COPERCHIO	COVER	COUVERCLE	DECKEL	TAPA
13 1474110002	1 NR	MOTORE IDRAULICO	HYDRAULIC MOTOR	MOTEUR HYDRAULIQUE	HYDRAULIKMOTOR	MOTOR HIDRÁULICO

 SOTTOCARRO CINGOLATO

 RAUPENFAHRWERK 
 TRACKED UNDERCARRIAGE

 CARRO DE ORUGAS 
 CHENILLARD

POS Codice	Q.tà	 Descrizione	 Description	 Designation	 Benennung	 Descripcìon
14 1450590003	1 NR	VALVOLA IDRAULICA	HYDRAULIC VALVE	VALVE HYDRAULIQUE	VALVE HYDRAULIQUE	VÁLVULA HIDRÁULICA
15 1450590004	1 NR	KIT GUARNIZIONI COMPLETO PER 145059NV-147411 NV-15041600	SEALS COMPLETE KIT 145059 147411 NV-NV-15041600	KIT JOINTS	DICHTUNGSSATZ	KIT JUNTAS

 ALLARGAMENTO IDRAULICO

 HYDRAULIC EXTENSION



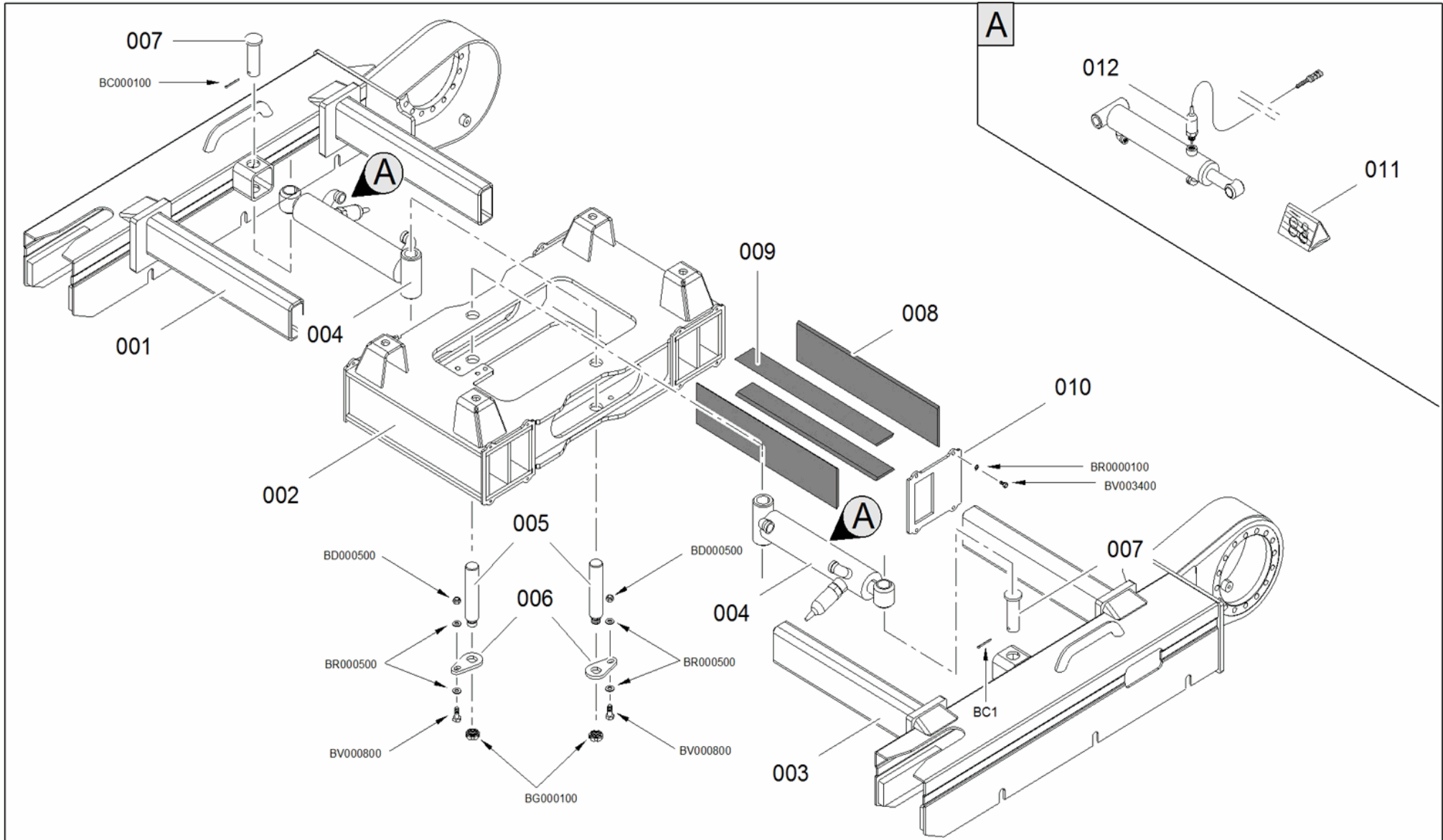

 ECARTEMENT HYDRAULIQUE

HYDR. SPURWEITENVER STELLEINRICHTUNG 





EXTENSION HIDRAULICA 







 ALLARGAMENTO IDRAULICOHYDR. SPURWEITENVER STELLEINRICHTUNG  HYDRAULIC EXTENSIONEXTENSION HIDRAULICA  ECARTEMENT HYDRAULIQUE

POS Codice	Q.tà	 Descrizione	 Description	 Designation	 Benennung	 Descripción
1 378038H2	1 NR	LONGHERONE DESTRO SOTTOCARRO ALLARGABILE LL1570 SINGOLA VELOCITA' HINOWA GREY	LONGHERONE RIGHT EXTENDABLE UNDERCARRIAG E LL1570 SINGLE SPEED 'HINOWA GREY	TRAIN DE CHENILLE DROITE	RECHTER FAHRSCHEIFF	PARTE CARRO DERECHO
2 377559H2	1 NR	STRUTTURA CENTRALE SOTTOCARRO LL1570 SALDATA	CENTRAL STRUCTURE UNDERCARRIAG E LL1570 WELDED	ESTRUCTURE CENTRALE	MITTELBAU	ESTRUCTURA CENTRAL
3 378039H2	1 NR	LONGHERONE DESTRO SOTTOCARRO ALLARGABILE LL1570 SINGOLA VELOCITA' HINOWA GREY	LONGHERONE RIGHT EXTENDABLE UNDERCARRIAG E LL1570 SINGLE SPEED 'HINOWA GREY	TRAIN DE CHENILLE DROIT	RECHTER FAHRSCHEIFF	PARTE CARRO DERECHO
4 277103H2	2 NR	CILINDRO ALLARGAMENTO CARRO LL1570-X15JP-X4 30AJ	CYLINDER ENLARGEMENT CARRIAGE LL1570-X15JP-X4 30AJ	CYLINDRE ÉLARGISSEMENT	SPURVERBREITE RUNGSZYLINDER	CILINDRO ENSANCHAMIENTO O
5 06023800	2 NR	SPINA FONDELLO ALLARGAMENTO	BOTTOM PLUG ENLARGEMENT	BAS PLUG ELARGISSEMENT	UNTEN PLUG ERWEITERUNG	BASE ENCHUFE AMPLIACIÓN

 ALLARGAMENTO IDRAULICO
HYDR. SPURWEITENVER STELLEINRICHTUNG 
 HYDRAULIC EXTENSION
EXTENSION HIDRAULICA 
 ECARTEMENT HYDRAULIQUE

POS Codice	Q.tà	 Descrizione	 Description	 Designation	 Benennung	 Descripcìon
6 064965Y1	2 NR	GOCCIA SPINA	PIN DROP	BAISSE CHEVILLE	TROPFEN	CAÍDA CLAVIJA
7 04256300	2 NR	SPINA	PIN	CHEVILLE	STIFT	CLAVIJA
8 07758900	8 NR	GUIDA ALLARGAMENTO LL1570-X15JP-X4 30AJ 88X4.2X374	ENLARGEMENT GUIDE LL1570-X15JP-X4 30AJ 88X4.2X374	GUIDE	FÜHRUNG	GUÍA
9 07758800	8 NR	GUIDA ALLARGAMENTO LL1570 48X4.2X374	GUIDE	GUIDE	FÜHRUNG	GUÍA
10 377580H2	4 NR	COPERCHIO FERMO GUIDE ALLARGAMENTO LL1570	COVER GUIDE ENLARGEMENT LL1570	COUVERCLE	ABDECKUNG	TAPA
11 2771030001	1 NR	KIT GUARNIZIONE CILINDRO ALLARGAMENTO CARRO LL1570 X15JP X430AJ	CYLINDER SEAL KIT CARRIAGE ENLARGEMENT LL1570 X15JP X430AJ	KIT JOINT	DICHTUNGSSATZ	KIT JUNTAS

 ALLARGAMENTO IDRAULICOHYDR. SPURWEITENVER STELLEINRICHTUNG  HYDRAULIC EXTENSIONEXTENSION HIDRAULICA  ECARTEMENT HYDRAULIQUE

POS Codice	Q.tà	 Descrizione	 Description	 Designation	 Benennung	 Descripcìon
12 17329500	2 NR	MICROINTERRUTT ORE ALLARGAMENTO CARRO N/O COMPLETO DI CAVO E CONNETTORE	WIDENING SYSTEM MICRO SWITCH N/O CONTACT WITH CABLE AND CONNECTOR	MICRO INTERRUPTEUR ELARGISSEMENT AVEC CABLE ET CONNECTEUR	MIKROSCHALTER SPURVERBREITE RUNG MIT KABEL UND STECKER	MICROINTERRUP TOR ENSANCHAMIENT O CON CABLE Y CONECTOR

 BASE TORRETTA

ARBEITSTURM 



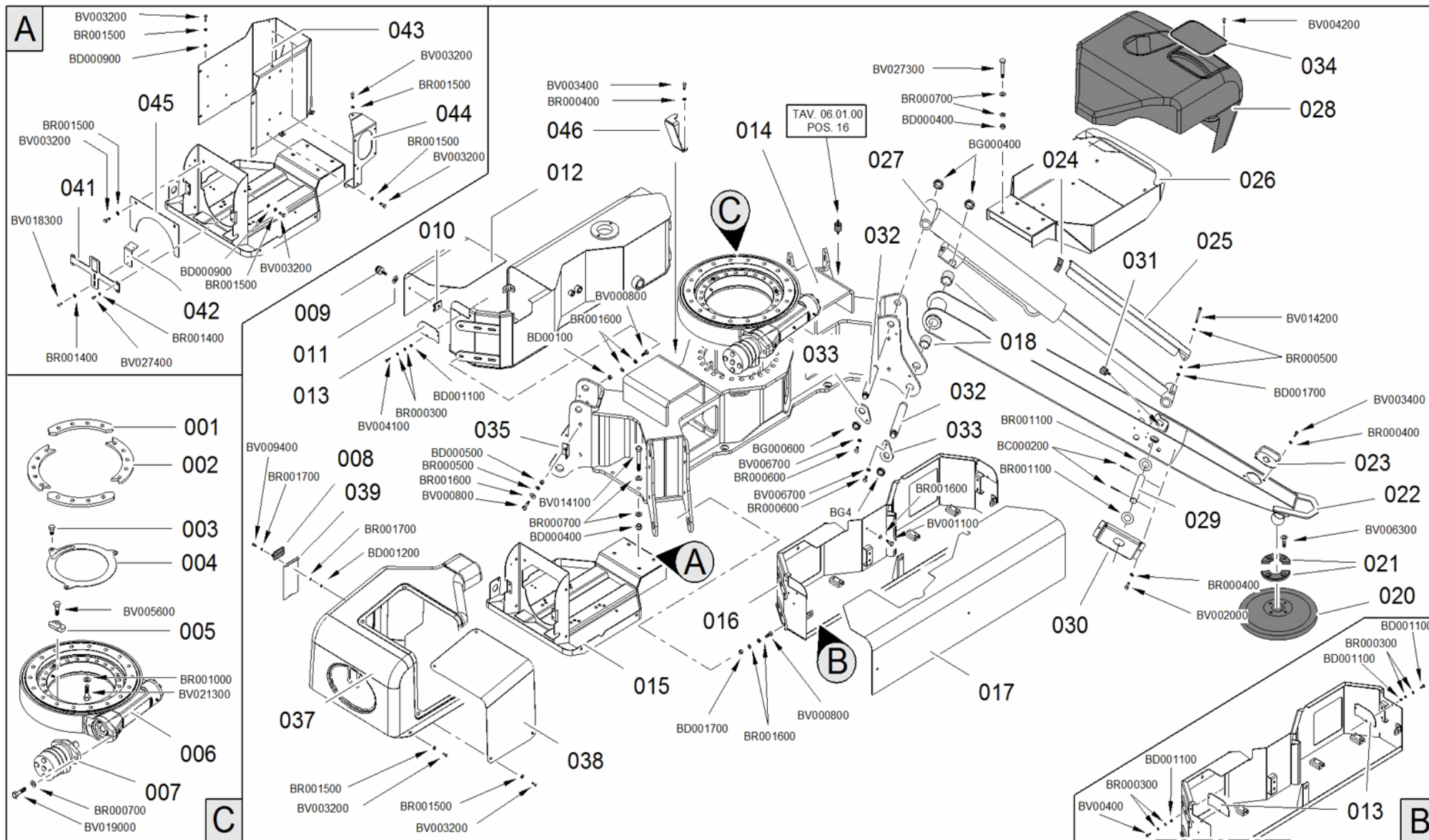

 TURRET BASE

BASE TORRETA GIRATORIA 





 BASE TOURELLE







 BASE TORRETTAARBEITSTURM  TURRET BASEBASE TORRETTA GIRATORIA  BASE TOURELLE

POS Codice	Q.tà	 Descrizione	 Description	 Designation	 Benennung	 Descripcìon
1 069349Y1	2 NR	SPESSORE	THICKNESS	CALE	STÄRKE	ESPEJOR
2 069348Y1	2 NR	SPESSORE	THICKNESS	CALE	STÄRKE	ESPEJOR
4 077710Y1	1 NR	RISCONTRO	FASTENER LOCATOR	PLAQUE POUR AGRAFAGE	ANSCHLAG	GANCHO
5 068911Y1	1 NR	FERMO	RETAINER	ARRÊT	HALTERUNG	BLOQUE
6 269450H2	1 NR	RALLA	FIFTH WHEEL	COURONNE DENTÉE	DREHKRANZ	TEJUELO
7 261308H2	1 NR	MOTORE DI ROTAZIONE	ROTARY MOTOR	MOTEUR DE ROTATION	ROTATIONSMOTOR	MOTOR DE ROTACIÓN
8 07178700	4 NR	CERNIERA CON CONTROLLO DELLA POSIZIONE	HINGES WITH POSITION CONTROL	CHARNIÈRE	SCHARNIER	BISAGRA
9 07343200	6 NR	VITE IMPERDIBILE ZIGRINATA CORTA	SHORT IMPERDIBLE KNURLED SCREW	VIS IMPERDABLE	SCHRAUBE	TORNILLO IMPERDIBLE
10 07343300	5 NR	RICETTACOLO PER VITE IMPERDIBILE	RECEPTACLE FOR IMPERDIBLE SCREW	PRISE DE VIS POUR VIS IMPERDABLE	AUFNAHME FÜR SCHRAUBE	REFUGIO TORNILLO IMPERDIBLE
10 07343300	1 NR	RICETTACOLO PER VITE IMPERDIBILE	RECEPTACLE FOR IMPERDIBLE SCREW	PRISE DE VIS POUR VIS IMPERDABLE	AUFNAHME FÜR SCHRAUBE	REFUGIO TORNILLO IMPERDIBLE





 BASE TORRETTA
ARBEITSTURM 
 TURRET BASE
BASE TORRETA GIRATORIA 
 BASE TOURELLE

POS Codice	Q.tà	 Descrizione	 Description	 Designation	 Benennung	 Descripción
11 07343400	6 NR	AGGANCIO PER VITE IMPERDIBILE	COUPLING FOR IMPERDIBLE SCREW	CROCHET VIS IMPERDABLE	HAKEN FÜR SCHRAUBE	GANCHO TORNILLO IMPERDIBLE
12 077481H1	1 NR	COPERCHIO VANO BATTERIA	COVER BATTERY COMPARTMENT	COUVERCLE	DECKEL	TAPA
13 077446H1	3 NR	TAPPO	CAP	COUVERCLE	ABDECKUNG	TAPA
14 377414H2	1 NR	BASE LL1570 SALDATA	BASE LL1570 WELDED	BASE LL1570 SAUDÉE	LL1570 GESCHWEISSTE BASIS	BASE SOLDATA LL1570
15 377732H2	1 NR	ASSIEME SUPPORTO COMPONENTI ELETTRICI LL1570 SALDATO	ASSEMBLY SUPPORT ELECTRICAL COMPONENTS LL1570 WELDED	ENSEMBLE SUPPORT COMPOSANT ÉLECTRIQUES LL1570	HALTERUNG FÜR ELEKTRISCHE KOMPONENTEN	SOPORTE COMPONENTES ELÉCTRICOS
16 377439H1	1 NR	SCATOLA IMPIANTO IDRAULICO	BOX HYDRAULIC	BOITE	GEHÄUSE	CAJA
17 077447H1	1 NR	COPERCHIO VANO COMPONENTI IDRAULICI	COVER HYDRAULIC COMPONENTS	COUVERCLE	ABDECKUNG	TAPA
18 07765300	2 NR	BOCCOLA DEVA.TEX552 253030	BUSH DEVA. TEX 552 253030	DOUILLE	BUCHSE	CASQUILLO
20 05446300	4 NR	DISCO	DISK	DISQUE	SCHEIBE	DISCO





 BASE TORRETTAARBEITSTURM  TURRET BASEBASE TORRETTA GIRATORIA  BASE TOURELLE

POS Codice	Q.tà	 Descrizione	 Description	 Designation	 Benennung	 Descripción
21 073147Y1	8 NR	SEMIFLANGIA	HALF FLANGE	DEMI-BRIDE	HALB FLANSCH	SEMI BRIDA
22 177406H2	4 NR	ASSIEME STABILIZZATORE COMPLETO	ASSEMBLY COMPLETE STABILIZER	STABILISATEUR COMPLET	ABSTÜTZUNG KOMPLETT	ESTABILIZADOR COMPLETO
23 376018H2	4 NR	SUPPORTO SPIA STABILIZZATORE (FOR LL2010-X20JP-X6 00AJ MK2 FROM C170000893)	OUTRIGGER LIGHT SUPPORT (FOR LL2010-X20JP-X6 00AJ MK2 FROM C170000893)	SUPPORT LUMIÈRE STABILISATEUR (FOR LL2010-X20JP-X6 00AJ MK2 FROM C170000893)	LICHTHALTERUN G (FOR LL2010-X20JP-X6 00AJ MK2 FROM C170000893)	SOPORTE LUZ (FOR LL2010-X20JP-X6 00AJ MK2 FROM C170000893)
24 07894900	4 NR	GOMMA ADESIVA DI PROTEZIONE L=70	RUBBER ADHESIVE PROTECTION L=70	GOMME ADHESIVE DE PROTECTION L=70	SCHUTZ-KLEBEG UMMI L=70	GOMA ADHESIVA DE PROTECCIÓN L=70
25 072700H2	4 NR	CARTER DI PROTEZIONE	PROTECTION COVER	CARTER DE PROTECTION	CARTER VON SCHUTZ	CARTER DE PROTECCIÓN
26 377484H2	1 NR	SUPPORTO MOTORE TERMICO LL1570 SALDATO	SUPPORT ENGINE LL1570 WELDED	SUPPORT MOTEUR	HALTERUNG FÜR MOTOR	SOPORTE MOTOR
27 277102H2	4 NR	CILINDRO STABILIZZATORE LL1570-X15JP-X4 30AJ	CYLINDER STABILIZER LL1570-X15JP-X4 30AJ	CYLINDER STABILISATEUR	ABSTÜTZUNGSZY LINDER	CILINDRO ESTABILIZADOR





 BASE TORRETTA
ARBEITSTURM 
 TURRET BASE
BASE TORRETTA GIRATORIA 
 BASE TOURELLE

POS Codice	Q.tà	 Descrizione	 Description	 Designation	 Benennung	 Descripción
28 377954H2	1 NR	COFANO MOTORE BENZINA	ENGINE COVER PETROL	CAPOT MOTEUR ESSENCE	MOTORHAUBE FÜR BENZIN MOTOR	CAPÓ PARA MOTOR DE GASOLINA
29 07754600	4 NR	SPINA OCCHIO CILINDRO STABILIZZATORE LL1570-X15JP-X4 30AJ	PIN EYE CYLINDER STABILIZER LL1570-X15JP-X4 30AJ	AXE	STIFT	CLAVIJA
30 077413H2	4 NR	PIEGATO PROTEZIONE MICRO STABILIZZATORE	BENT PROTECTION MICRO STABILIZER	PROTECTION MICROINTERRUP TEUR	SCHUTZABDECK UNG MIKROSCHALTER	PROTECCIÓN MICROINTERRUP TOR
31 05876400	4 NR	ANTIVIBRANTE	ANTI-VIBRATING	ANTI - VIBRANT	VIBRATIONS DÄM PFER	ANTIVIBRANTE
32 07772000	8 NR	PERNO ATTACCO STABILIZZATORE A BASE LL1570-X15JP-X4 30AJ	PIN CONNECTION STABILIZER BASED LL1570-X15JP-X4 30AJ	AXE	STIFT	PERNIO
33 064966Y1	13 NR	GOCCIA SPINA	PIN DROP	BAISSE CHEVILLE	TROPFEN STIFT	CAÍDA CLAVIJA
34 077955H2	1 NR	COPERCHIO PER ACCESSO A FILTRO ARIA SU MOTORE BENZINA	COVER FOR ACCESS TO AIR FILTER ON GASOLINE ENGINE	COUVERCLE	DECKEL	TAPA

 BASE TORRETTA
ARBEITSTURM 
 TURRET BASE
BASE TORRETA GIRATORIA 
 BASE TOURELLE

POS Codice	Q.tà	 Descrizione	 Description	 Designation	 Benennung	 Descripción
35 055629H3	1 NR	STAFFA	BRACKET	ÉTRIER	HALTEBÜGEL	ESTRIBO
37 077742H2	1 NR	COFANO MOTORE ELETTRICO	ELECTRIC ENGINE COVER	CAPOT	MOTOR HAUBE	CAPÓ
38 077743H2	1 NR	PORTELLO LATERALE MANUTENZIONE MOTORE ELETTRICO	DOOR LATERAL MAINTENANCE ELECTRIC MOTOR	GUICHET	ABDECKPLATTE	PORTILLA
39 077744H2	1 NR	PORTELLO ACCESSO CHIAVE EMERGENZE	DOOR ACCESS KEY EMERGENCIES	GUICHET	ABDECKPLATTE	PORTILLA
41 077745Y1	1 NR	PIATTO FISSAGGIO FOTOCELLULA CATAFORESI	PLATE FIXING PHOTOCELL	PLAQUE	PLATTE	PLACA
42 061185Y1	1 NR	LAMIERA PIEGATA	FOLDED PLATE	TÔLE PLIÉE	BLECH GEBOGEN	CHAPA DOBLADA
43 077738Y1	1 NR	PIEGATO FISSAGGIO COMPONENTI ELETTRICI LL1570	BENT FIXING ELECTRICAL COMPONENTS LL1570	SUPPORT	HALTERUNG	SOPORTE
44 077739Y1	1 NR	PIEGATO FISSAGGIO MODEM LL1570	BENT SECURING MODEM LL1570	SUPPORT	HALTERUNG	SOPORTE

 BASE TORRETTAARBEITSTURM  TURRET BASEBASE TORRETA GIRATORIA  BASE TOURELLE

POS Codice	Q.tà	 Descrizione	 Description	 Designation	 Benennung	 Descripcìon
45 077740Y1	1 NR	PARATIA SUPERIORE MOTORE ELETTRICO LL1570	UPPER PLATE ELECTRIC MOTOR LL1570	PLAQUE	PLATTE	PLACA
46 077721D2	1 NR	INDICE ALLINEAMENTO FISSO LL1570	ALIGNMENT INDEX FIXED LL1570	INDEX	INDEX	ÍNDICE

 SERBATOIO OLIO

 OIL TANK



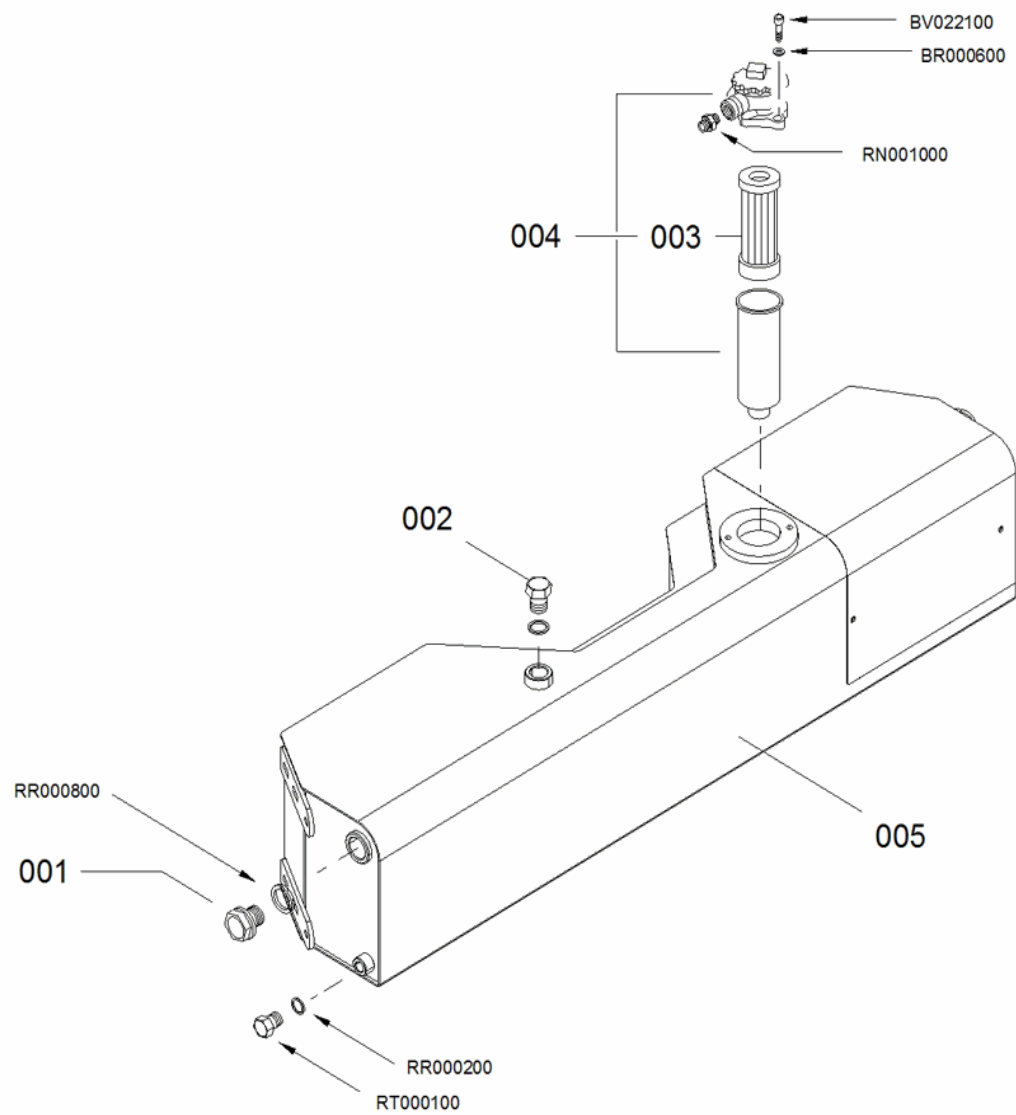

 RÉSERVOIR D'HUILE

ÖLTANK 

DEPÓSITO DE ACEITE 



 SERBATOIO OLIOÖLTANK  OIL TANKDEPÓSITO DE ACEITE  RÉSERVOIR D'HUILE

POS Codice	Q.tà	 Descrizione	 Description	 Designation	 Benennung	 Descripcìon
1 05061800	1 NR	LIVELLO OLIO	OIL LEVEL	NIVEAU HUILE	ÖLSTAND	NIVEL ACEITE
2 05611800	1 NR	TAPPO OLIO	OIL PLUG	BOUCHON D'HUILE	ÖLDECKEL	TAPÓN ACEITE
3 05120200	1 NR	CARTUCCIA FILTRO OLIO IDRAULICO	OIL FILTER INSERT	CARTOUCHE FILTRE À HUILE	ÖLFILTEREINSAT Z	CARTUCHO FILTRO ACEITE
4 15120100	1 NR	FILTRO OLIO IDRAULICO COMPLETO	COMPLETE HYDRAULIC OIL FILTER	FILTRE À HUILE	HYDARULIKÖLFIL TER	FILTRO ACEITE HIDRÁULICO
5 177477H1	1 NR	SERBATOIO OLIO COMPLETO	OIL TANK COMPLETE	RESERVOIR HUILE COMPLET	ÖLTANK KOMPLETT	DEPOSITO ACEITE COMPLETO

 PRIMO BRACCIO

 FIRST ARM



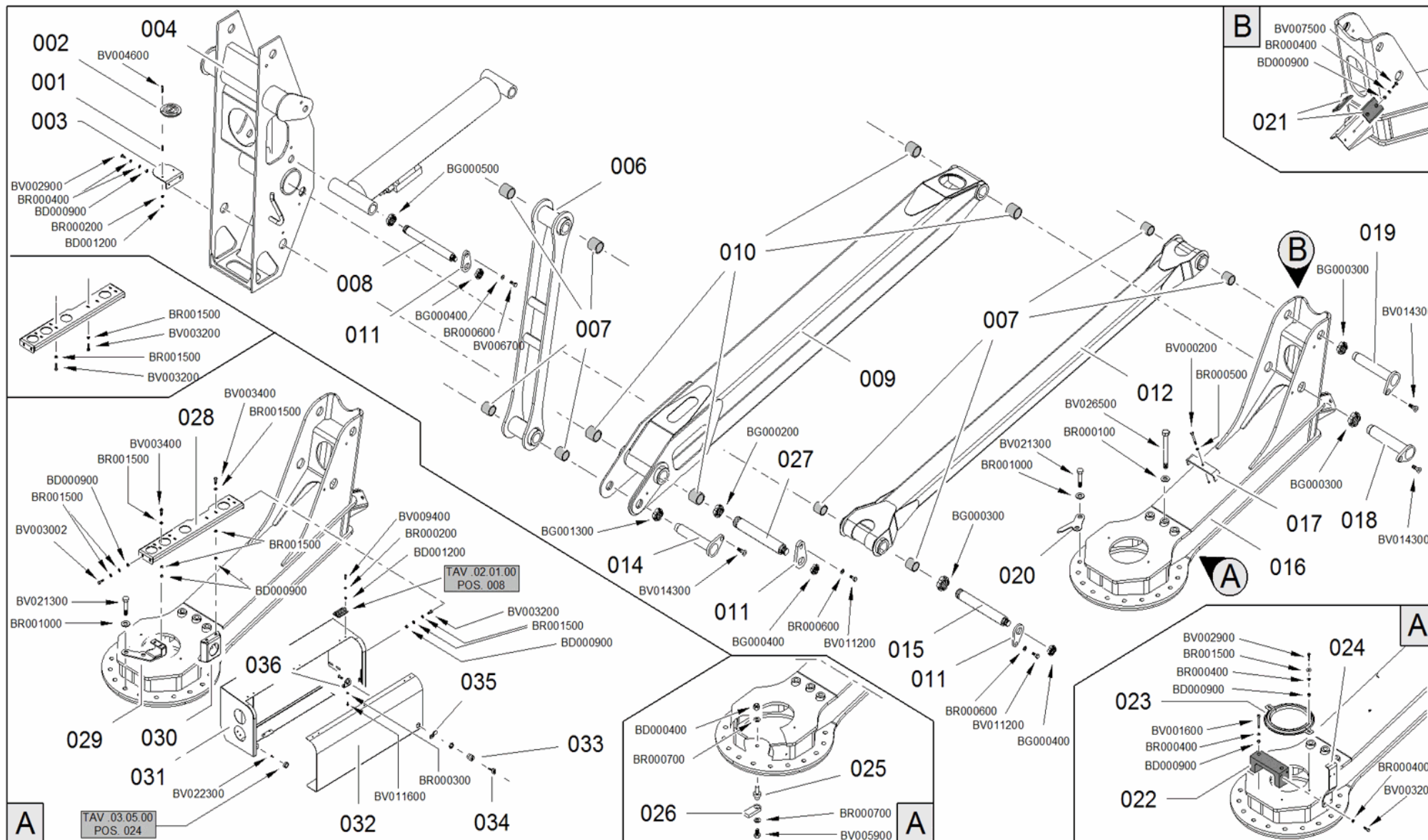

 PREMIER BRAS

ERSTER AUSLEGERARM 





PRIMO BRAZO 







 PRIMO BRACCIOERSTER AUSLEGERARM  FIRST ARMPRIMO BRAZO  PREMIER BRAS

POS Codice	Q.tà	 Descrizione	 Description	 Designation	 Benennung	 Descripción
1 05444800	3 NR	MOLLA	SPRING	RESSORT	FEDER	MUELLE
2 05427200	1 NR	LIVELLA	LEVEL	NIVEAU	WASSERWAAGE	NIVEL DE BURBUJA
3 058832H3	1 NR	SUPPORTO	SUPPORT	SUPPORT	HALTERUNG	SOPORTE
4 377599H1	1 NR	RINVIO PRIMO-SECONDO BRACCIO	REFERENCE FIRST-SECON BOOM	RENOI PREMIER-DEUXIE ME BRAS	VORGELEGE ERSTER-ZWEITE R ARM	REENVIO PRIMERO-SEGUN DO BRAZO
6 177114H1	1 NR	BIELLA PRIMO-SECONDO BRACCIO	ROD FIRST-SECON BOOM	BIELLE	PLEUELSTANGE	BIELA
7 07765100	4 NR	BOCCOLA DEVA.TEX552 354040	BUSH DEVA. TEX 552 354040	DOUILLE	BUCHSE	CASQUILLO
7 07765100	4 NR	BOCCOLA DEVA.TEX552 354040	BUSH DEVA. TEX 552 354040	DOUILLE	BUCHSE	CASQUILLO
8 07755000	1 NR	SPINA FONDELLO CILINDRO 1°2°BRACCIO LL1570-X15JP-X4 30AJ	PIN BOTTOM CYLINDER 1ST 2ND ARM LL1570-X15JP-X4 30AJ	AXE	STIFT	CLAVIJA
9 177590H1	1 NR	PRIMO BRACCIO COMPLETO	FIRST BOOM COMPLETE	PREMIER BRAS COMPLET	ERSTER ARM KOMPLETT	PRIMERO BRAZO COMPLETO





 PRIMO BRACCIO
ERSTER AUSLEGERARM 
 FIRST ARM
PRIMO BRAZO 
 PREMIER BRAS

POS Codice	Q.tà	 Descrizione	 Description	 Designation	 Benennung	 Descripcìon
10 07765000	4 NR	BOCCOLA DEVA. TEX552 404540	BUSH DEVA. TEX 552 404540	DOUILLE	BUCHSE	CASQUILLO
11 064967Y1	12 NR	GOCCIA SPINA	PIN DROP	BAISSE CHEVILLE	TROPFEN STIFT	CAÍDA CLAVIJA
12 177117H1	1 NR	TIRANTE PRIMO BRACCIO	FIRST TIE BOOM	TIRANT	TURMGESTÄNGE	TIRANTE
14 07755200	1 NR	PERNO ATTACCO BIELLA A 1°BRACCIO LL1570-X15JP-X4 30AJ	PIN CONNECTION ROD A 1ST ARM LL1570-X15JP-X4 30AJ	AXE	STIFT	CLAVIJA
14 07755200	1 NR	PERNO ATTACCO BIELLA A 1°BRACCIO LL1570-X15JP-X4 30AJ	PIN CONNECTION ROD A 1ST ARM LL1570-X15JP-X4 30AJ	AXE	STIFT	CLAVIJA





 PRIMO BRACCIOERSTER AUSLEGERARM  FIRST ARMPRIMO BRAZO  PREMIER BRAS

POS Codice	Q.tà	 Descrizione	 Description	 Designation	 Benennung	 Descripción
15 07754900	1 NR	PERNO ATTACCO TIRANTE 1°BRACCIO A RINVIO 1°2°BRACCIO LL1570-X15JP-X4 30AJ	PIN CONNECTION TIE 1ST ARM REFERENCE 1ST 2ND ARM LL1570-X15JP-X4 30AJ	AXE	STIFT	CLAVIJA
15 07754900	1 NR	PERNO ATTACCO TIRANTE 1°BRACCIO A RINVIO 1°2°BRACCIO LL1570-X15JP-X4 30AJ	PIN CONNECTION TIE 1ST ARM REFERENCE 1ST 2ND ARM LL1570-X15JP-X4 30AJ	AXE	STIFT	CLAVIJA
16 377429H1	1 NR	SUPPORTO BRACCI	BOOM SUPPORT	SUPPORT BRAS	ÄRMEHALTERUN G	SOPORTE BRAZOS
17 060372Y2	1 NR	FERMO	RETAINER	ARRÊT	HALTERUNG	SUJETADOR
18 07754700	1 NR	PERNO ATTACCO 1° BRACCIO A SUPPORTO BRACCI LL1570-X15JP-X4 30AJ	PIN CONNECTION 1ST ARM SUPPORT ARMS LL1570-X15JP-X4 30AJ	AXE	STIFT	CLAVIJA





 PRIMO BRACCIOERSTER AUSLEGERARM  FIRST ARMPRIMO BRAZO  PREMIER BRAS

POS Codice	Q.tà	 Descrizione	 Description	 Designation	 Benennung	 Descripción
19 07754800	1 NR	PERNO ATTACCO TIRANTE 1°BRACCIO A SUPPORTO BRACCI LL1570-X15JP-X4 30AJ	PIN CONNECTION TIE 1ST ARM SUPPORT ARMS LL1570-X15JP-X4 30AJ	AXE	STIFT	CLAVIJA
20 071531D2	1 NR	INDICE ALLINEAMENTO	ALIGNMENT INDICATOR	INDICATEUR D'ALIGNEMENT	AUSRICHTUNGS- ANZEIGE	INDICADOR ALINEACIÓN
21 05849000	4 NR	PATTINO	SLIDE BLOCK	PATIN	GLEITBLOCK	PATÍN
22 07771600	1 NR	TAMPONE APPOGGIO PRIMO BRACCIO LL1570	BUFFER FOR SUPPORT FIRST ARM LL1570	TAMPON	PUFFER	TAMPÓN
23 069590H3	1 NR	PROTEZIONE	PROTECTION	PROTECTION	SCHUTZ	PROTECCIÓN
24 077717H3	1 NR	STAFFA FISSAGGIO MICRO PRIMO BRACCIO	BRACKET MICRO FIRST BOOM	BRIDE	BÜGEL	BRIDA
25 068912Y1	1 NR	PERNO	PIN	GOUJON	ZAPFEN	PERNIO
26 064422Y1	1 NR	FERMO	RETAINER	ARRÊT	HALTEVORRICHT- UNG	BLOQUE
27 07539800	1 NR	SPINA	PIN	AXE	STIFT	CLAVIJA

 PRIMO BRACCIO
ERSTER AUSLEGERARM 
 FIRST ARM
PRIMO BRAZO 
 PREMIER BRAS

POS Codice	Q.tà	 Descrizione	 Description	 Designation	 Benennung	 Descripción
28 077556H3	1 NR	PIEGATO FISSAGGIO DISTRIBUTORE LL1570	BENT FITTING DISTRIBUTOR LL1570	SUPPORT	HALTERUNG	SOPORTE
29 077558H2	1 NR	PIEGATO ANTERIORE SUPPORTO DISTRIBUTORE	BENT FRONT SUPPORT DISTRIBUTOR	SUPPORT	HALTERUNG	SOPORTE
30 077557H2	1 NR	PIEGATO POSTERIORE SUPPORTO DISTRIBUTORE	BENT BACK SUPPORT DISTRIBUTOR	SUPPORT	HALTERUNG	SOPORTE
31 373142H2	1 NR	CARTER DISTRIBUTORE BRACCI (FOR LL1775-X17JP-X5 00AJ MK2 FROM C170000893)	PROTECTION BOOM HYDRAULIC DISTRIBUTOR (FOR LL1775-X17JP-X5 00AJ MK2 FROM C170000893)	PROTECTION DISTRIBUTEUR (FOR LL1775-X17JP-X5 00AJ MK2 FROM C170000893)	SCHUTZ VENTILBLOCK (FOR LL1775-X17JP-X5 00AJ MK2 FROM C170000893)	PROTECCION DISTRIBUIDOR (FOR LL1775-X17JP-X5 00AJ MK2 FROM C170000893)
32 073144H2	1 NR	COPERCHIO (FOR LL1775-X17JP-X5 00AJ MK2 FROM C170000893)	COVER (FOR LL1775-X17JP-X5 00AJ MK2 FROM C170000893)	COUVERTURE (FOR LL1775-X17JP-X5 00AJ MK2 FROM C170000893)	DECKUNG (FOR LL1775-X17JP-X5 00AJ MK2 FROM C170000893)	COBERTURA (FOR LL1775-X17JP-X5 00AJ MK2 FROM C170000893)
33 07178800	1 NR	SERRATURA	LOCK	SERRURE	SCHLOSS	CERRADURA

 PRIMO BRACCIOERSTER AUSLEGERARM  FIRST ARMPRIMO BRAZO  PREMIER BRAS

POS Codice	Q.tà	 Descrizione	 Description	 Designation	 Benennung	 Descripción
34 07298800	1 NR	CHIAVE PER SERRATURA POSTAZIONE COMANDO A TERRA	KEY TO THE LOCK ON THE GROUND CONTROL POSITION	CLÉ	SCHLÜSSEL	LLAVE
35 07178900	1 NR	CAMMA PER SERRATURA DISASSAMENTO 3.2	CAM LOCK FOR OFFSET 3.2	CAME	NOCKEN	LEVA
36 073138Y1	1 NR	SUPPORTO SERRATURA	LOCK SUPPORT	SUPPORT SERRURE	SCHLOSSHALTE RUNG	SOPORTE CERRADURA

 SECONDO BRACCIO

ZWEITER AUSLEGERARM 



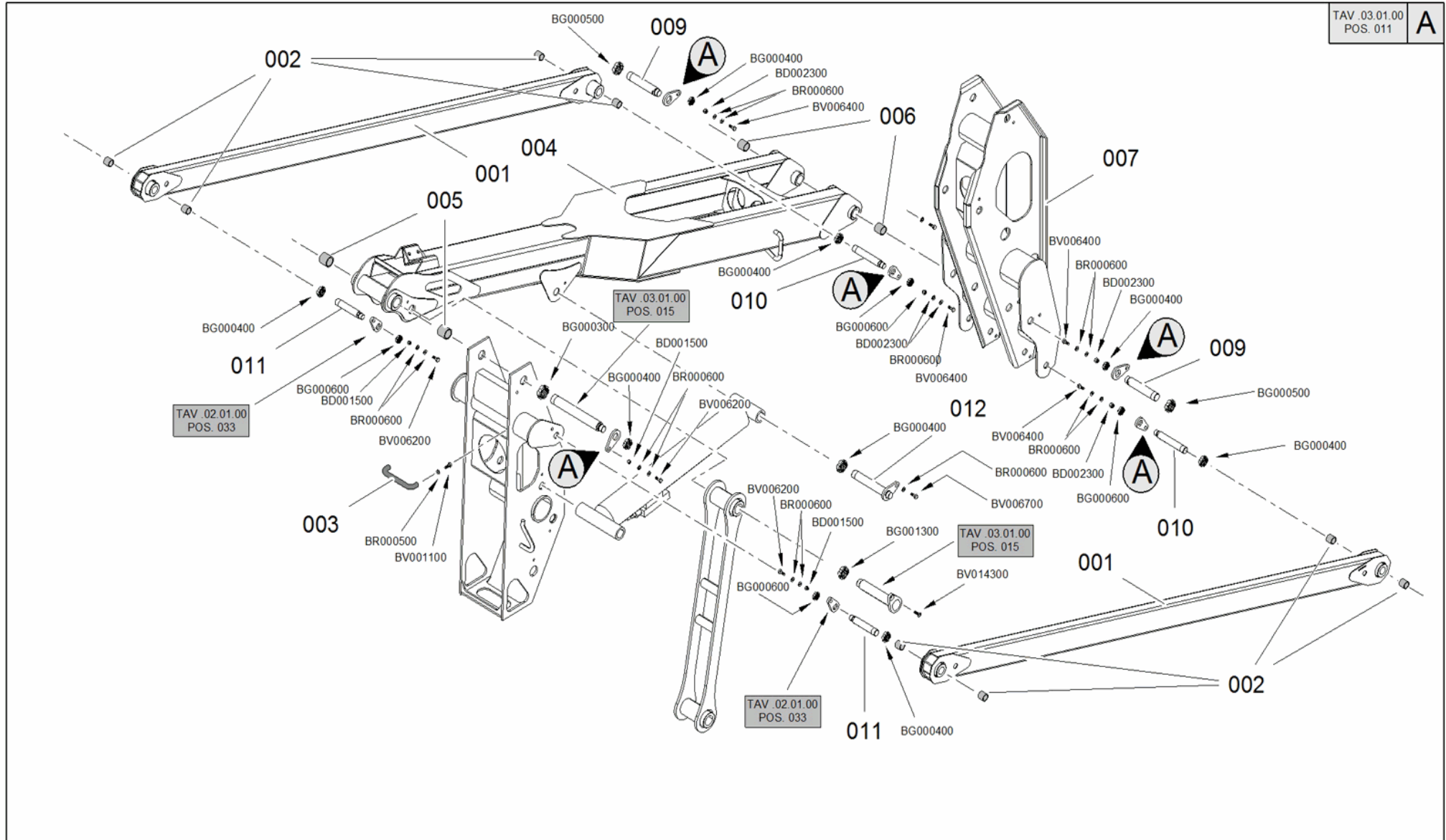

 SECOND ARM

SEGUNDO BRAZO 





 SECOND BRAS



 SECONDO BRACCIO
ZWEITER AUSLEGERARM 
 SECOND ARM
SEGUNDO BRAZO 
 SECOND BRAS

POS Codice	Q.tà	 Descrizione	 Description	 Designation	 Benennung	 Descripción
1 177347H1	2 NR	TIRANTE SECONDO BRACCIO	SECOND TIE BOOM	TIRANT	TURMGESTÄNGE	TIRANTE
2 07765300	4 NR	BOCCOLA DEVA.TEX552 253030	BUSH DEVA. TEX 552 253030	DOUILLE	BUCHSE	CASQUILLO
3 07154000	1 NR	MANIGLIA	HANDLE	POIGNÉE	GRIFF	MANIJA
4 177610H1	1 NR	SECONDO BRACCIO COMPLETO	SECOND BOOM COMPLETE	DEUXIEME BRAS COMPLET	ZWEITER ARM KOMPLETT	SEGUNDO BRAZO COMPLETO
5 07765100	2 NR	BOCCOLA DEVA.TEX552 354040	BUSH DEVA. TEX 552 354040	DOUILLE	BUCHSE	CASQUILLO
6 07765200	4 NR	BOCCOLA DEVA.TEX552 303530	BUSH DEVA. TEX 552 303530	DOUILLE	BUCHSE	CASQUILLO
7 377352H1	1 NR	RINVIO SECONDO-TERZ O BRACCIO	REFERENCE SECOND-THIRD BOOM	RENVOI DEUXIEME-TROIS IEME BRAS	VORGELEGE ZWEITER-DRITTE R ARM	REENVIO SEGUNDO-TERZE RO BRAZO
9 07755300	2 NR	PERNO ATTACCO TIRANTE 2°BRACCIO A RINVIO 2°3°BRACCIO LL1570-X15JP-X4 30AJ	PIN CONNECTION ROD 2ND ARM REFERENCE 2ND 3RD ARM LL1570-X15JP-X4 30AJ	AXE	STIFT	CLAVIJA

 SECONDO BRACCIO
ZWEITER AUSLEGERARM 
 SECOND ARM
SEGUNDO BRAZO 
 SECOND BRAS

POS Codice	Q.tà	 Descrizione	 Description	 Designation	 Benennung	 Descripcìon
10 07271600	2 NR	SPINA	PIN	CHEVILLE	STIF	CLAVIJA
11 07755100	2 NR	PERNO ATTACCO TIRANTE 2°BRACCIOA RINVIO 1°2°BRACCIO LL1570-X15JP-X4 30AJ	PIN CONNECTION ROD 2ND ARM REFERENCE 1ST 2ND ARM LL1570-X15JP-X4 30AJ	AXE	STIFT	CLAVIJA
12 07093900	1 NR	SPINA	PIN	CHEVILLE	STIF	CLAVIJA

 TERZO BRACCIO

 THIRD ARM

 TIERS BRAS

THIRD AUSLEGERARM 



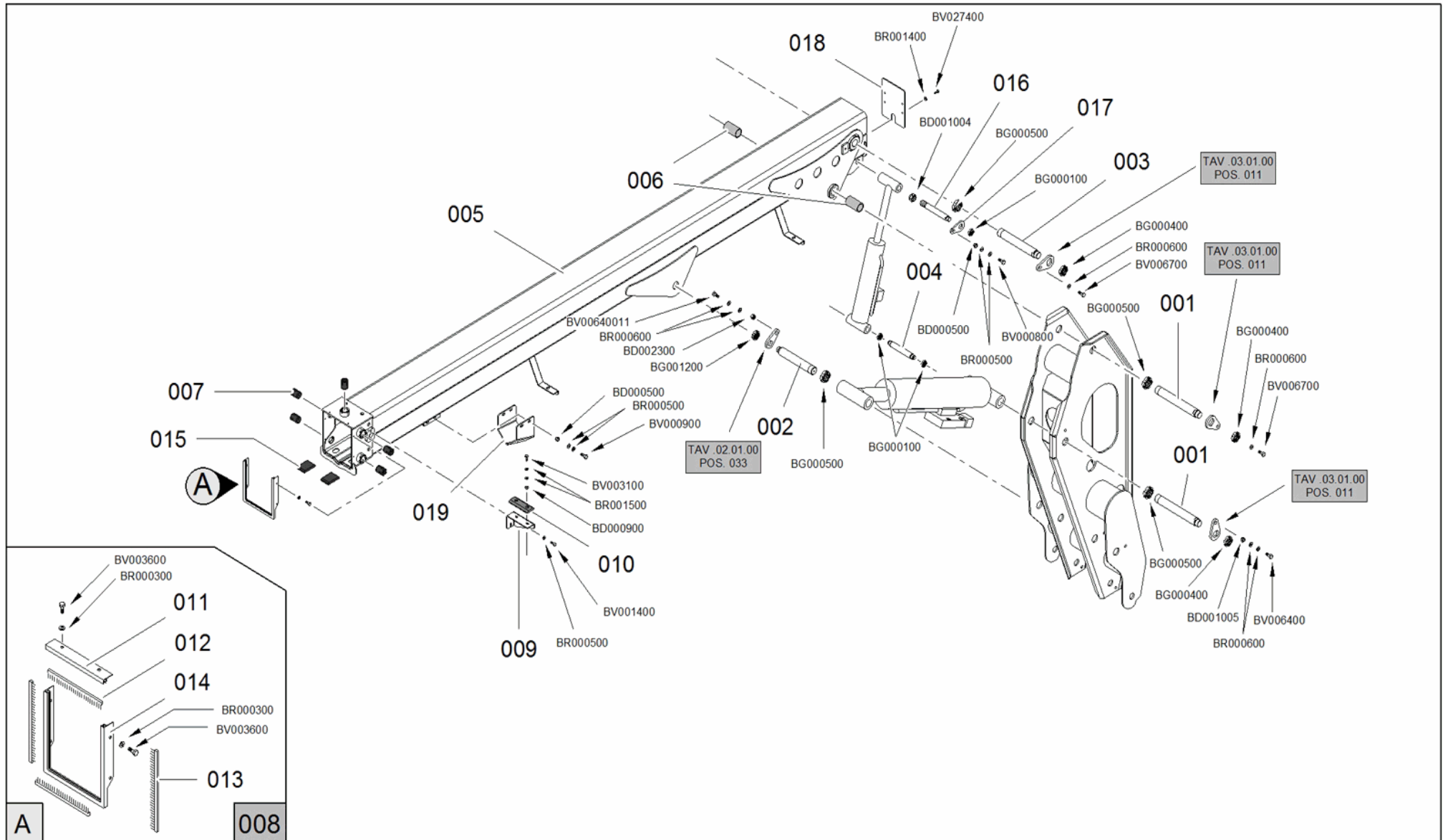

TERCERO BRAZO 







 TERZO BRACCIO

 THIRD AUSLEGERARM 
 THIRD ARM

 TERCERO BRAZO 
 TIERS BRAS

POS Codice	Q.tà	 Descrizione	 Description	 Designation	 Benennung	 Descripción
1 07094900	2 NR	SPINA	PIN	CHEVILLE	STIF	CLAVIJA
2 06561000	1 NR	SPINA	PIN	CHEVILLE	STIF	CLAVIJA
3 07102500	1 NR	SPINA	PIN	CHEVILLE	STIF	CLAVIJA
4 06867600	1 NR	SPINA	PIN	CHEVILLE	STIFT	CLAVIJA
5 177366H1	1 NR	TERZO BRACCIO COMPLETO	THIRD BOOM COMPLETE	TROISIEME BRAS COMPLET	DRITTER ARM KOMPLETT	TERCERO BRAZO COMPLETO
6 07765200	2 NR	BOCCOLA DEVA.TEX552 303530	BUSH DEVA.TEX 552 303530	DOUILLE	BUCHSE	CASQUILLO
6 07765200	2 NR	BOCCOLA DEVA.TEX552 303530	BUSH DEVA.TEX 552 303530	DOUILLE	BUCHSE	CASQUILLO
7 06958600	5 NR	PATTINO	SLIDE BLOCK	PATIN	GLEITBLOCK	PATÍN
8 17767600	1 NR	KIT SPAZZOLE TERZO BRACCIO LL2010	BRUSHES KIT	KIT BROSSES	BÜRSTENSATZ	KIT CEPILLOS
9 068663H3	1 NR	SUPPORTO	SUPPORT	SUPPORT	HALTERUNG	SOPORTE
10 06867100	1 NR	PATTINO	SLIDE BLOCK	PATIN	GLEITBLOCK	PATÍN
11 07101600	1 NR	PROFILO SPAZZOLE SUPERIORE	PROFILE BRUSH TOP	CHÂSSIS	RAHMEN	BASTIDOR

 TERZO BRACCIO
THIRD AUSLEGERARM 
 THIRD ARM
TERCERO BRAZO 
 TIERS BRAS

POS Codice	Q.tà	 Descrizione	 Description	 Designation	 Benennung	 Descripcìon
12 07102000	2 NR	SPAZZOLA ORRIZONTALE	HORIZONTAL BRUSH	BROSSE HORIZONTALE	WAAGRECHTE BÜRSTE	CEPILLO HORIZONTAL
13 07102100	2 NR	SPAZZOLA VERTICALE	VERTICAL BRUSH	BROSSE VERTICALE	SENKRECHTE BÜRSTE	CEPILLO VERTICAL
14 07754300	1 NR	PIEGATO FISSAGGIO SPAZZOLE	BENT FITTING BRUSHES	SUPPORT	HALTERUNG	SOPORTE
15 07754200	2 NR	PATTINO APPOGGIO SFILÒ SU TERZO BRACCIO LL1570	SKID SUPPORT EXTENSION ON THIRD BOOM LL1570	PATIN	GLEITSCHUH	PATÍN
16 06230600	1 NR	SPINA	PIN	CHEVILLE	STIFT	CLAVIJA
17 064965Y1	11 NR	GOCCIA SPINA	PIN DROP	BAISSE CHEVILLE	TROPFEN	CAÍDA CLAVIJA
18 077536H3	1 NR	CARTER POSTERIORE TERZO BRACCIO	CARTER BACK THIRD BOOM	CARTER	KURBELGEHÄUS E	CÁRTER
19 077380H3	1 NR	PIEGATO CENTRAGGIO TERZO BRACCIO LL1570	BENDED CENTRING THIRD BOOM LL1570	SUPPORT	HALTERUNG	SOPORTE

 CATENA PORTACAVI FLESSIBILE

 FLEXIBLE CABLE-HOLDER CHAIN



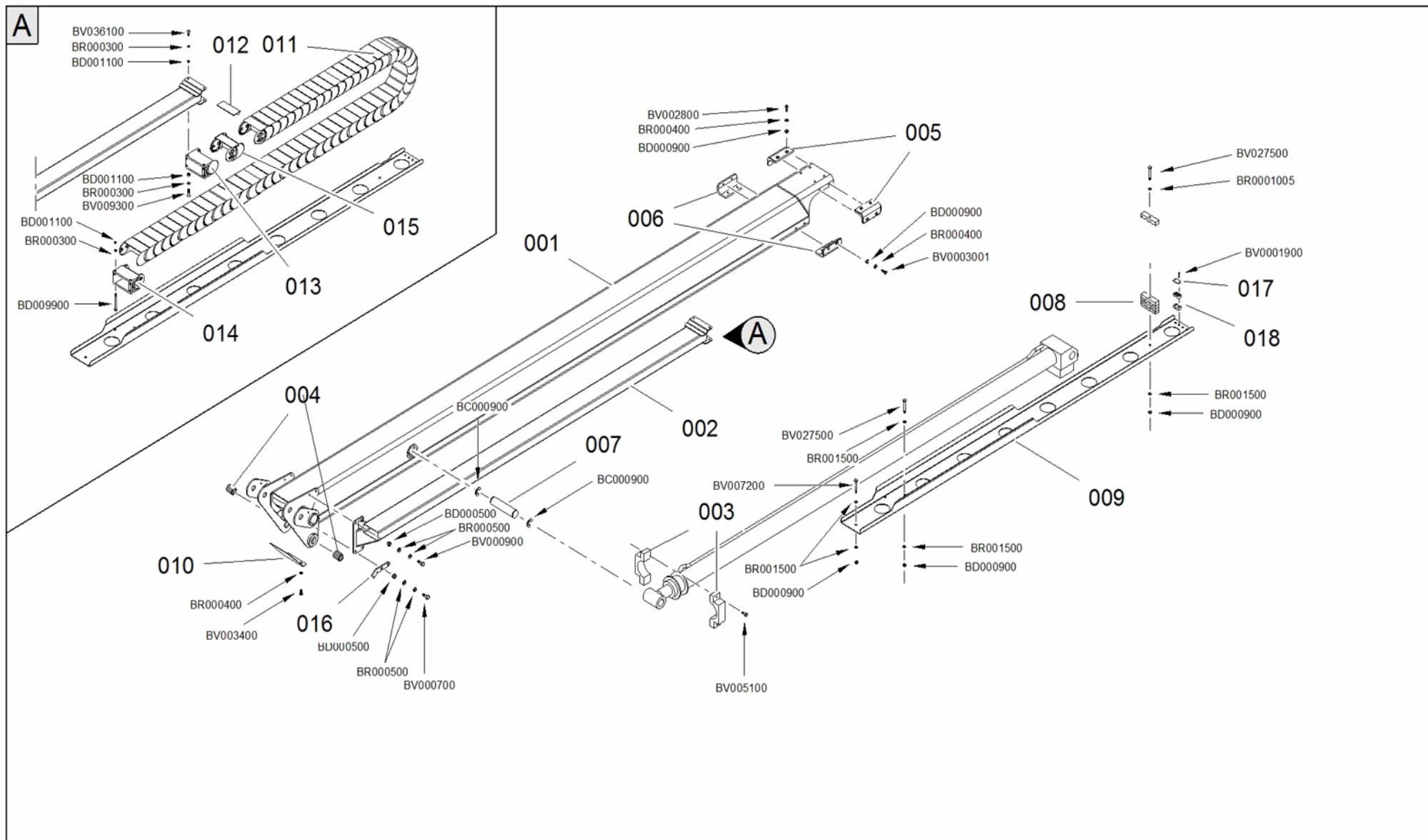

 CHAÎNE PORTE-CABLES FLEXIBLE

SCHLAUCH SCHLEPPKETTE 





CADENA PORTACABLES FLEXIBLE 



 CATENA PORTACAVI FLESSIBILE
SCHLAUCH SCHLEPPKETTE 
 FLEXIBLE CABLE-HOLDER CHAIN
CADENA PORTACABLES FLEXIBLE 
 CHAINE PORTE-CABLES FLEXIBLE

POS Codice	Q.tà	 Descrizione	 Description	 Designation	 Benennung	 Descripcìon
1 177104H1	1 NR	BRACCIO SFILO COMPLETO	COMPLETE EXTENSION BOOM	BRAS D'EXTENSION	ARMVERLÄNGER UNG	BRAZO TELESCÓPICO
2 377362H3	1 NR	ASSIEME SUPPORTO CATENARIA SFILO LL1570 SALDATO	ASSEMBLY SUPPORT CONTACT LINE EXTENSION LL1570 WELDED	SUPPORT	HALTERUNG	SOPORTE
3 07767500	1 NR	PATTINO GUIDA CILINDRO SFILO LL1570	SKID GUIDE CYLINDER EXTENSION LL1570	PATIN	GLEITSCHUH	PATÍN
4 07765800	2 NR	BOCCOLA DEVA.TEX552 202815	BUSH DEVA.TEX 552 202815	DOUILLE	BUCHSE	CASQUILLO
5 07178200	2 NR	PATTINO	SLIDE BLOCK	PATIN	GLEITBLOCK	PATÍN
6 07711300	2 NR	PATTINO	SLIDE BLOCK	PATIN	GLEITBLOCK	PATÍN
7 06853800	1 NR	SPINA	PIN	CHEVILLE	STIF	CLAVIJA
8 07530500	3 NR	MORSETTO FERMA TUBI	CLAMP	ÉTAU	KLEMMME	ABRAZADERA
9 077534H3	1 NR	PIEGATO SUPPORTO CATENARIA SFILO LL1570	BENDED WIRE SUPPORT CATENARY LL1570	SUPPORT	HALTERUNG	SOPORTE

 CATENA PORTACAVI FLESSIBILE
SCHLAUCH SCHLEPPKETTE 
 FLEXIBLE CABLE-HOLDER CHAIN
CADENA PORTACABLES FLEXIBLE 
 CHAÎNE PORTE-CABLES FLEXIBLE

POS Codice	Q.tà	 Descrizione	 Description	 Designation	 Benennung	 Descripción
10 071314H3	1 NR	COPERCHIO ANTERIORE SFILO	FRONT COVER EXTENSION	COUVERCLE	DECKEL	TAPA
11 27766400	1 NR	CATENA PORTACAVI	CABLE-HOLDER CHAIN	CHAÎNE PORTE-CÂBLES	KABELHALTERKETTE	CADENA PORTACABLES
12 2595050004	1 NR	COPERCHIO	COVER	COUVERCLE	DECKEL	TAPA
13 2595050001	1 NR	MAGLIA CATENA ATTACCO FEMMINA	CHAIN LINK FEMALE CONNECTION	MAILLOT CHAÎNE	KETTENGLIED	ESLABÓN CADENA
14 2595050002	1 NR	MAGLIA CATENA ATTACCO MASCHIO	CHAIN LINK MALE CONNECTION	MAILLOT CHAÎNE	KETTENGLIED	ESLABÓN CADENA
15 2595050003	1 NR	MAGLIA CATENA	CHAIN LINK	MAILLOT CHAÎNE	KETTENGLIED	ESLABÓN CADENA
16 072263H3	1 NR	STAFFA	BRACKET	ÉTRIER	HALTEBÜGEL	ESTRIBO
17 04096600	2 NR	PIASTRA	CLAMP	BRIDE	KLEMME	PLACA
18 04096800	4 NR	MORSETTO	CLAMP	BRIDE	KLEMME	BORNE

 SUPPORTO CESTO

 BASKET SUPPORT



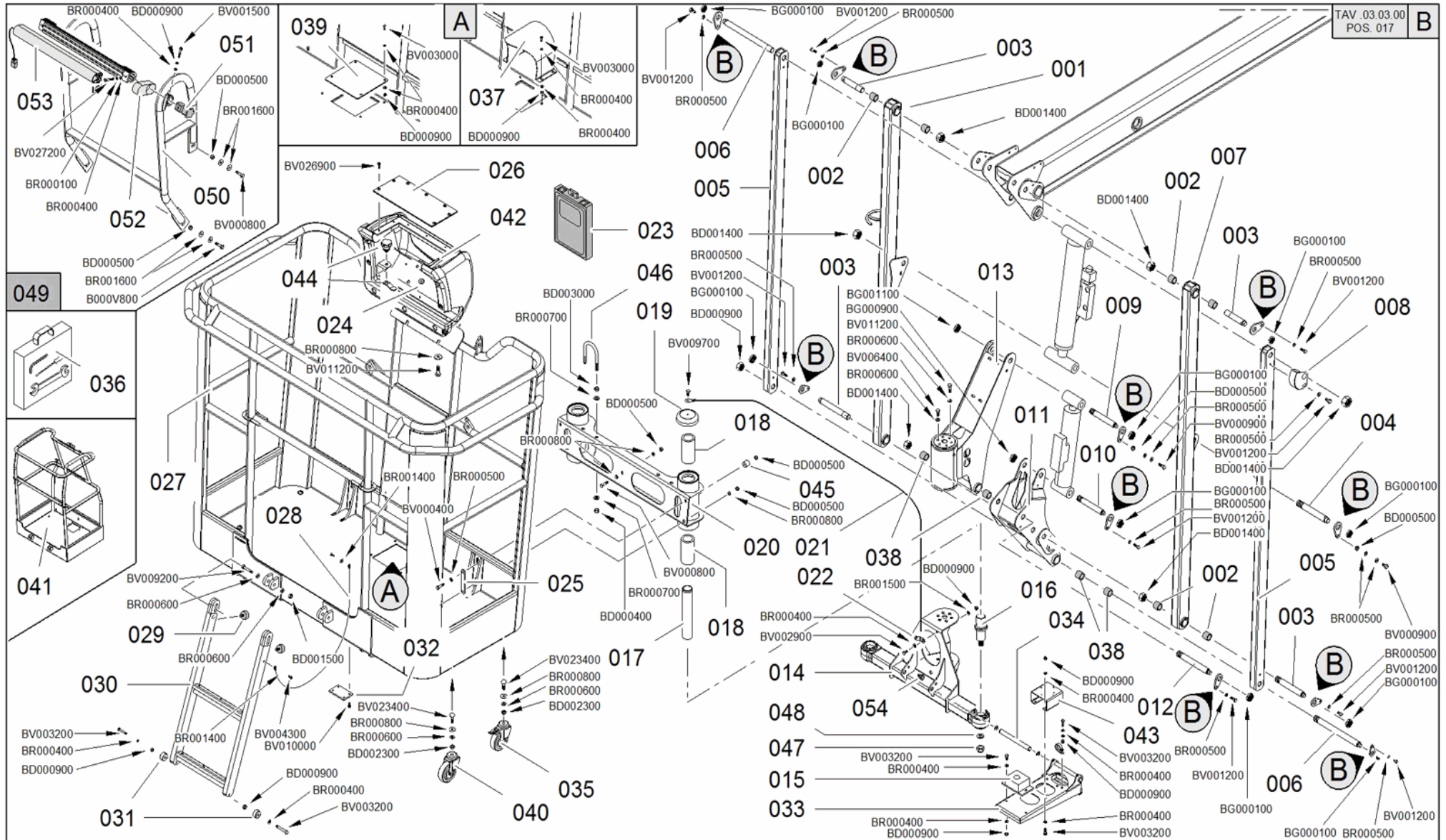

 PANIER CUPPORT

HALTERUNG ARBEITSKORB 

SOPORTE CESTA 







 SUPPORTO CESTO
HALTERUNG ARBEITSKORB 
 BASKET SUPPORT
SOPORTE CESTA 
 PANIER CUPPORT

POS Codice	Q.tà	 Descrizione	 Description	 Designation	 Benennung	 Descripcìon
1 177718H1	1 NR	ASSIEME BRACCIO JIB DESTRO COMPLETO	ASSEMBLY BOOM JIB RIGHT COMPLETE	BRAS JIB DROIT COMPLET	RECHTER JIB ARM KOMPLETT	BRAZO JIB DERECHO COMPLETO
2 07765600	4 NR	BOCCOLA DEVA.TEX552 202820	BUSH DEVA.TEX 552 202820	DOUILLE	BUCHSE	CASQUILLO
2 07765600	4 NR	BOCCOLA DEVA.TEX552 202820	BUSH DEVA.TEX 552 202820	DOUILLE	BUCHSE	CASQUILLO
3 07093500	4 NR	SPINA	PIN	CHEVILLE	STIFT	CLAVIJA
4 07093800	1 NR	SPINA	PIN	CHEVILLE	STIFT	CLAVIJA
5 359447H1	2 NR	TIRANTE	TIE ROD	TIRANT	TURMGESTÄNGE	TIRANTE
6 07093600	2 NR	SPINA	PIN	CHEVILLE	STIFT	CLAVIJA
7 177719H1	1 NR	ASSIEME BRACCIO JIB SINISTRO COMPLETO	ASSEMBLY BOOM JIB LEFT COMPLETE	BRAS JIB GAUCHE COMPLET	RECHTER JIB ARM KOMPLETT	BRAZO JIB IZQUIERDO COMPLETO
8 377713H3	1 NR	CAMMA MICRO JIB	MICROSWITCH CAM JIB	CAME	NOCKEN	LEVA
9 07093700	1 NR	SPINA	PIN	CHEVILLE	STIFT	CLAVIJA
10 06235600	1 NR	SPINA	PIN	CHEVILLE	STIFT	CLAVIJA

 SUPPORTO CESTO

 HALTERUNG ARBEITSKORB 
 BASKET SUPPORT





 SOPORTE CESTA 
 PANIER CUPPORT

POS Codice	Q.tà	 Descrizione	 Description	 Designation	 Benennung	 Descripción
11 175401H1	1 NR	RINVIO JIB	UPRIGHT JIB	RENOVI	VORGELEGE	REENVIO
12 06235700	1 NR	SPINA	PIN	CHEVILLE	STIFT	CLAVIJA
13 271778H2	1 NR	MOTORE DI ROTAZIONE RAL7016	ROTARY MOTOR RAL7016	MOTEUR DE ROTATION RAL7016	DREHANTRIEB RAL7016	MOTOR ROTACIÓN RAL7016
13 2648910002	1 NR	KIT GUARNIZIONI	SEAL KIT	KIT DE JOINTS	DICHTUNGSSATZ	KIT DE JUNTAS
14 377660H2	1 NR	SUPPORTO CESTO	BASKET SUPPORT	SUPPORT PANIER	KORBHALTERU NG	SOPORTE CESTA
15 056187H3	1 NR	COPERCHIO	BOX	COUVERCLE	DECKEL	TAPA
16 07190900	2 NR	VITE TE DIN960 CI 8.8 M16X1.5X115 FORATA GEOMET321 PLUS XL	TE SCREW DIN960 CI 8.8 M16X1.5X115 GEOMET321 PERFORATED PLUS XL	VIS TE DIN960 CI 8,8 M16X1.5X115 FORE PLUS GEOMET321 XL	TE SCHRAUBE DIN960 CI 8,8 M16X1.5X115 GEOMET321 PERFORATED PLUS XL	TE TORNILLO DIN960 CI 8,8 M16X1.5X115 GEOMET321 PERFORADA XL
17 07146500	2 NR	PERNO SUPPORTO CESTO DIAM.50	PIN SUPPORT BASKET Ø50	AXE DIAM.50 PANIER DE SOUTIEN	BOLZEN KORBHALTERUN G	CLAVIJA CESTA
18 27146200	4 NR	CUSCINETTO LINEARE A SFERE 50-100	LINEAR BALL BEARING 50-100	ROULEMENT Á BILLES	LINEAR-KUGELLA GER 50-100	COJINETE DE BOLAS 50-100

 SUPPORTO CESTO

 HALTERUNG ARBEITSKORB 
 BASKET SUPPORT





 SOPORTE CESTA 
 PANIER CUPPORT

POS Codice	Q.tà	 Descrizione	 Description	 Designation	 Benennung	 Descripcìon
19 07146400	2 NR	TAPPO CHIUSURA PERNI SUPPORTO CESTO DIAM.50	CAP PINS BASKET SUPPORT Ø50	BOUCHON	VERSCHLUSS	TAPÓN
20 371459H2	1 NR	SLITTA FISSAGGIO CESTO PERNI DIAM.50	SLIDE BASKET MOUNTING BOLTS Ø50	COULISSEAU	SCHLITTEN	CORREDERA
21 06665000	2 NR	FUNE	CABLE	CÂBLE	SEIL	CABLE
22 07052900	1 NR	STAFFA	BRACKET	ÉTRIER	HALTEBÜGEL	ESTRIBO
23 05643600	1 NR	CASSETTA PORTAMANUALE	MANUAL BOX	BOÎTE PORTE-MANUEL	BEDIENUNGSANL EITUNGSFACH	CAJA PORTAMANUAL
24 06477600	1 NR	MAGNETE Ø20 CON FORO M3	MAGNETO Ø20 WITH M3 HOLE	AIMANT	MAGNET	IMÁN
25 072398H3	2 NR	PIASTRA FISSAGGIO CESTO (SOLO MACCHINE MODELLO JP E JA E X17J)	FIXING PLATE BASKET (ONLY MACHINES MODEL JP AND JA AND X17J)	PLATE FIXATION DRUM	PLATE BEFESTIGUNG DRUM	PLACA FIJACIÓN TAMBOR
26 07690700	1 NR	PROTEZIONE TRASPARENTE	PROTECTION	PROTECTION	SCHUTZ	PROTECCIÓN

 SUPPORTO CESTO

 HALTERUNG ARBEITSKORB 
 BASKET SUPPORT





 SOPORTE CESTA 
 PANIER CUPPORT

POS Codice	Q.tà	 Descrizione	 Description	 Designation	 Benennung	 Descripción
27 27589300	1 NR	CESTO BIPOSTO 230KG PER MK2 (DA C170000893)	BASKET 2 PERSON 230KG FOR MK2 (FROM C170000893)	PANIER 2 PERSONNES POUR MK2 (FROM C170000893)	2 MANN-ARBEITSK ORB FÜR MK2 (FROM C170000893)	CESTA 2 PERSONAS PARA MK2 (FROM C170000893)
28 06598500	1 NR	FUNE	CABLE	CÂBLE	SEIL	CABLE
29 05475900	2 NR	ANTIVIBRANTE	ANTI-VIBRATING	ANTI - VIBRANT	VIBRATIONSDÄM PFER	ANTIVIBRANTE
30 36585800	1 NR	SCALETTA	LADDER	ÉCHELLE REPLIABLE	LEITER	ESCALERA PLEGABLE
31 06585900	2 NR	ROTELLINA	SMALL ROLLER	ROULETTE	RÄDCHEN	RUEDECILLA
32 058600H3	1 NR	PIASTRA	PLATE	PLAQUE	PLATTE	PLACA
33 377661H2	1 NR	MENSOLA SUPPORTO CELLA DI CARICO	BRACKET SUPPORT LOAD CELL	BRIDE SUPPORT CELLULE DE CHARGE	STEIGBÜGELHAL TERUNG FÜRLASTÜBERW ACHUNGSZELLE	BRIDA SOPORTE CELULA DE CARGA
34 07766500	1 NR	PERNO INCERNIERAMEN TO MENSOLA SUPPORTO CESTO	PIN HINGE BRACKET SUPPORT BASKET	AXE	STIFT	PERNIO
35 07751100	2 NR	RUOTE INFERIORI PER CESTO CON FRENO	LOWER WHEELS FOR BASKET WITH BRAKE	ROUES POUR PANIER	KORBRÄDER	RUEDAS

 SUPPORTO CESTO

 HALTERUNG ARBEITSKORB 
 BASKET SUPPORT





 SOPORTE CESTA 
 PANIER CUPPORT

POS Codice	Q.tà	 Descrizione	 Description	 Designation	 Benennung	 Descripción
36 16549800	1 NR	KIT ATTREZZI	TOOL KIT	KIT OUTILS	GERÄTESATZ	KIT DE HERRAMIENTAS
38 06272700	2 NR	BOCCOLA	BUSH	DOUILLE	BUCHSE	CASQUILLO
38 06272700	2 NR	BOCCOLA	BUSH	DOUILLE	BUCHSE	CASQUILLO
39 06895900	1 NR	PIASTRA	PLATE	PLAQUE	PLATTE	PLACA
40 07687300	2 NR	RUOTE INFERIORI PER CESTO	LOWER WHEEL	ROULEAU INFERIEUR	UNTERES RAD	RUEDA INFERIOR
42 17569900	1 NR	PROTEZIONE TELECOMANDO	PROTECTION REMOTE CONTROL	PROTECTION	SCHUTZ	PROTECCIÓN
44 07192700	1 NR	CHIUSURA A VOLANTINO CON LEVA PIEGATA (SOLO MACCHINE MODELLO JP E JA E X17J)	LOCKING WHEEL WITH BENT LEVER (ONLY MACHINES MODEL JP AND JA AND X17J)	POIGNEE DE BLOCAGE	KUGELVERSCHL USS	POMO DE BLOQUEO
45 07239700	2 NR	DISTANZIALE PER VITI M8 SUPPORTO CESTO (SOLO MACCHINE MODELLO JP E JA E X17J)	SPACER SCREW M8 SUPPORT BASKET (ONLY MACHINES MODEL JP AND JA AND X17J)	ENTRETOISE	DISTANZSTÜCK	DISTANCIADOR

 SUPPORTO CESTO

 HALTERUNG ARBEITSKORB 
 BASKET SUPPORT

 SOPORTE CESTA 
 PANIER CUPPORT

POS Codice	Q.tà	 Descrizione	 Description	 Designation	 Benennung	 Descripcìon
46 07031800	2 NR	TUBO	PIPE	TUYAU	ROHR	TUBO
47 07193000	2 NR	DADO AD INTAGLI UNI5593 CI 8 M16X1.5 GEOMET321 PLUS XL	NUT M16X1.5 NOTCHES UNI5593 CI 8 GEOMET321 PLUS XL	ÉCROU UNI5593 CI 8 M16X1.5 GEOMET321 PLUS XL	MUTTER UNI5593 CI 8 M16X1.5 GEOMET321 PLUS XL	TUERCA UNI5593 CI 8 M16X1.5 GEOMET321 PLUS XL
48 07192600	2 NR	RONDELLA SPECIALE HV 300 - D 17X48X6 GEOMET321/A+P LUS XL	SPECIAL WASHER HV 300 - 17X48X6 GEOMET321 D / A + PLUS XL	RONDELLE SPECIALE HV 300 - 17X48X6 GEOMET321 D / A + PLUS XL	SCHEIBE HV 300 - 17X48X6 GEOMET321 D / A + PLUS XL	ARANDELA ESPECIAL HV 300 - 17X48X6 GEOMET321 D / A + PLUS XL
54 07771500	1 NR	MANIGLIA	HANDLE	POIGNÉE	GRIFF	MANIJA





 ACCOPPIAMENTO MOTORE DIESEL- POMPA

PUMPEN / DIESELMOTOR KUPPLUNG 

 DIESEL ENGINE COUPLING - PUMP

ACOPLAMIENTO MOTOR DIESEL- BOMBA 

 ACCOUPLEMENT MOTEUR DIESEL - POMPE

POS Codice	Q.tà	 Descrizione	 Description	 Designation	 Benennung	 Descripcìon
1 04310200	1 NR	SEMIGIUNTO	HALF COUPLING	DEMI-JOINT	HALBVERBINDUNG G	SEMI-ACOPLAMIE NTO
2 04310100	1 NR	INSERTO IN GOMMA	RUBBER INSERT	INSERT EN CAOUTCHOUC	GUMMIEINSATZ	INSERTO DE GOMA
3 04615300	1 NR	GIUNTO	COUPLING	JOINT	VERBINDUNG	ACOPLAMIENTO
4 04310300	1 NR	LANTERNA	LANTERN	LANTERNE	BUCHSE	LINTERNA
6 07804100	4 NR	ANTIVIBRANTE VERSIONE BENZINA	ANTI-VIBRATING GASOLINE VERSION	ANTI - VIBRANT	VIBRATIONSDÄM PFER	ANTIVIBRANTE
7 077494Y1	1 NR	PIATTO SINISTRO SUPPORTO MOTORE HONDA LL1570	LEFT PLATE SUPPORT HONDA MOTOR LL1570	PLAQUE GAUCHE SUPPORT MOTEUR	LINKE PLATTE MOTORHALTERU NG	PLACA IZQUIERDA SOPORTE MOTOR
8 077493Y1	1 NR	PIATTO DESTRO SUPPORTO MOTORE HONDA LL1570	RIGHT PLATE SUPPORT HONDA MOTOR LL1570	PLAQUE DROITE SUPPORT MOTEUR	RECHTE PLATTE MOTORHALTERU NG	PLACA DERECHA SOPORTE MOTOR
9 061177H2	1 NR	STAFFA	BRACKET	ÉTRIER	HALTEBÜGEL	ESTRIBO





 ACCOPPIAMENTO MOTORE DIESEL- POMPA

PUMPEN / DIESELMOTOR KUPPLUNG 

 DIESEL ENGINE COUPLING - PUMP

ACOPLAMIENTO MOTOR DIESEL- BOMBA 





 ACCOUPLEMENT MOTEUR DIESEL - POMPE

POS Codice	Q.tà	 Descrizione	 Description	 Designation	 Benennung	 Descripcìon
10 27775900	1 NR	MOTORE HONDA IGX390 MODIFICATO SENZA BLOCCHETTO CHIAVE DI ACCENSIONE MK2 (DA C170000893)	HONDA MOTOR IGX390 MODIFIED WITHOUT IGNITION SWITCH MK2 (FROM C170000893)	MOTEUR HONDA IGX390	HONDA MOTOR IGX390	MOTOR HONDA IGX390
23 17729600	1 NR	KIT ELE INTEGRAZIONE MOTORE BENZINA 13I LL1570	INTEGRATION KIT ELE MOTOR GASOLINE 13 THE LL1570	KIT ÉLECTRIQUE	ELEKTROSATZ	KIT ELÉCTRICO

 ACCOPPIAMENTO MOTORE DIESEL- POMPA

 PUMPEN / DIESELMOTOR KUPPLUNG 
 DIESEL ENGINE COUPLING - PUMP

 ACOPLAMIENTO MOTOR DIESEL- BOMBA 
 ACCOUPLEMENT MOTEUR DIESEL - POMPE

POS Codice	Q.tà	 Descrizione	 Description	 Designation	 Benennung	 Descripción
24 1776330003	1 NR	RELE' MINI TYCO 12V PER CONNETTORE A TENUTA (MK2 DA C170000893)	RELAY 'MINI 12V TYCO CONNECTOR SEAL (MK2 FROM C170000893)	RELAIS	RELAIS	RELÉ
24 1776330004	1 NR	PORTA RELE' A TENUTA PER MINI TYCO 12V (MK2 DA C170000893)	HOLDER RELAY SEAL FOR MINI 12V TYCO (MK2 FROM C170000893)	PORTE RELAIS	RELAISHALTER	PORTARELÉ
24 1776330005	1 NR	GOMMINO PER RELE' A TENUTA MINI TYCO 12V (MK2 DA C170000893)	RUBBER FOR RELAY SEAL MINI 12V TYCO (MK2 FROM C170000893)	JOINT RELÉ	GUMMIDICHTUNG	JUNTA DE GOMA
24 1776330007	1 NR	PUNTALINI PER RELE' A TENUTA MINI TYCO 12V (MK2 DA C170000893)	FERRULE FOR RELAY SEAL MINI 12V TYCO (MK2 FROM C170000893)	BORNE	KLEMME	BORNE
25 1757250022	1 NR	TAPPO CONNETTORE YAZAKI 2 VIE CON DIODO 1.5A	PLUG	BOUCHON	DECKEL	TAPA
26 1739150057	1 NR	FUSIBILE A LAMA DA 30A	FUSE BLADE 30A	FUSIBLE À LAME 30A	30 A SICHERUNG	FUSIBILE A LAMA 30A





 ACCOPPIAMENTO MOTORE DIESEL- POMPA

PUMPEN / DIESELMOTOR KUPPLUNG 

 DIESEL ENGINE COUPLING - PUMP

ACOPLAMIENTO MOTOR DIESEL- BOMBA 

 ACCOUPLEMENT MOTEUR DIESEL - POMPE

POS Codice	Q.tà	 Descrizione	 Description	 Designation	 Benennung	 Descripcìon
27 07819000	1 NR	PARATIA PROTEZIONE CARBURATORE	PLATE PROTECTION CARB	PLAQUE PROTECTION	SCHUTZPLATTE	PLACE PROTECCIÓN
28 17965000	1 NR	KIT RELE' AGGIUNTIVO SEGNALE MOTORE ACCESO HONDA IGX390	KIT RELAY 'ADDITIONAL SIGNAL ON HONDA MOTOR IGX390			

 RICAMBI MOTORE

 ENGINE SPARE PARTS

 PIÈCES DÉTACHÉES DU MOTEUR

MOTORERSATZTEILE 

REPUESTOS MOTOR 

GASOLINE HONDA iGX390

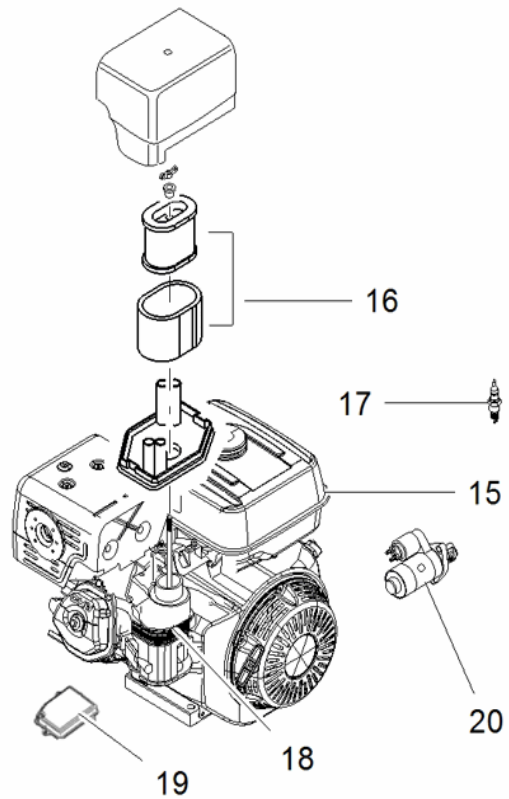



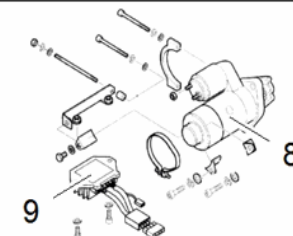
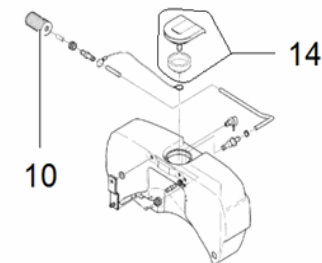
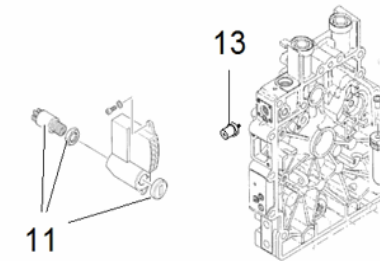
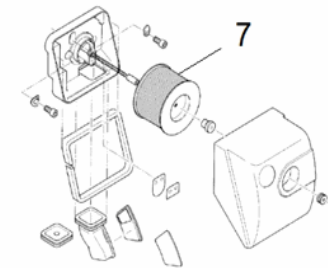

DIESEL HATZ 1B40



 RICAMBI MOTORE

 MOTORERSATZTEILE 
 ENGINE SPARE PARTS

 REPUESTOS MOTOR 
 PIÈCES DÉTACHÉES DU MOTEUR

POS Codice	Q.tà	 Descrizione	 Description	 Designation	 Benennung	 Descripción
15 2775200002	1 NR	SERBATOIO BENZINA COMPLETO HONDA IGX390	FUEL TANK COMPLETE HONDA IGX390	RÉSERVOIR ESSENCE	BENZINTANK	DEPÓSITO DE GASOLINA
16 2775200001	1 NR	CARTUCCIA FILTRO ARIA COMPLETA HONDA IGX390	AIR FILTER CARTRIDGE COMPLETE HONDA IGX390	FILTRE À AIR	LUFTFILTER	FILTRO DE AIRE
17 2558640032	1 NR	CANDELA IGX390 HONDA	SPARK PLUG IGX390 HONDA	BOUGIE	KERZE	BUJÍA
18 2775200003	1 NR	CARBURATORE COMPLETO HONDA IGX390	CARBURETOR COMPLETE HONDA IGX390	CARBURATEUR	VERGASER	CARBURADOR
19 2775200004	1 NR	CENTRALINA ELETTRONICA HONDA IGX390	ELECTRONIC CONTROL UNIT HONDA IGX390	UNITÉ ÉLECTRONIQUE	ELEKTRONISCHE EINHEIT	UNIDAD ELECTRÓNICA
20 2775200005	1 NR	MOTORINO DI AVVIAMENTO COMPLETO HONDA IGX390	ELECTRIC STARTER COMPLETE HONDA IGX390	MOTEUR DE DÉMARRAGE	MOTORSTART	MOTOR DE ARRANQUE

 MOTORE ELETTRICO

 ELECTRIC MOTOR



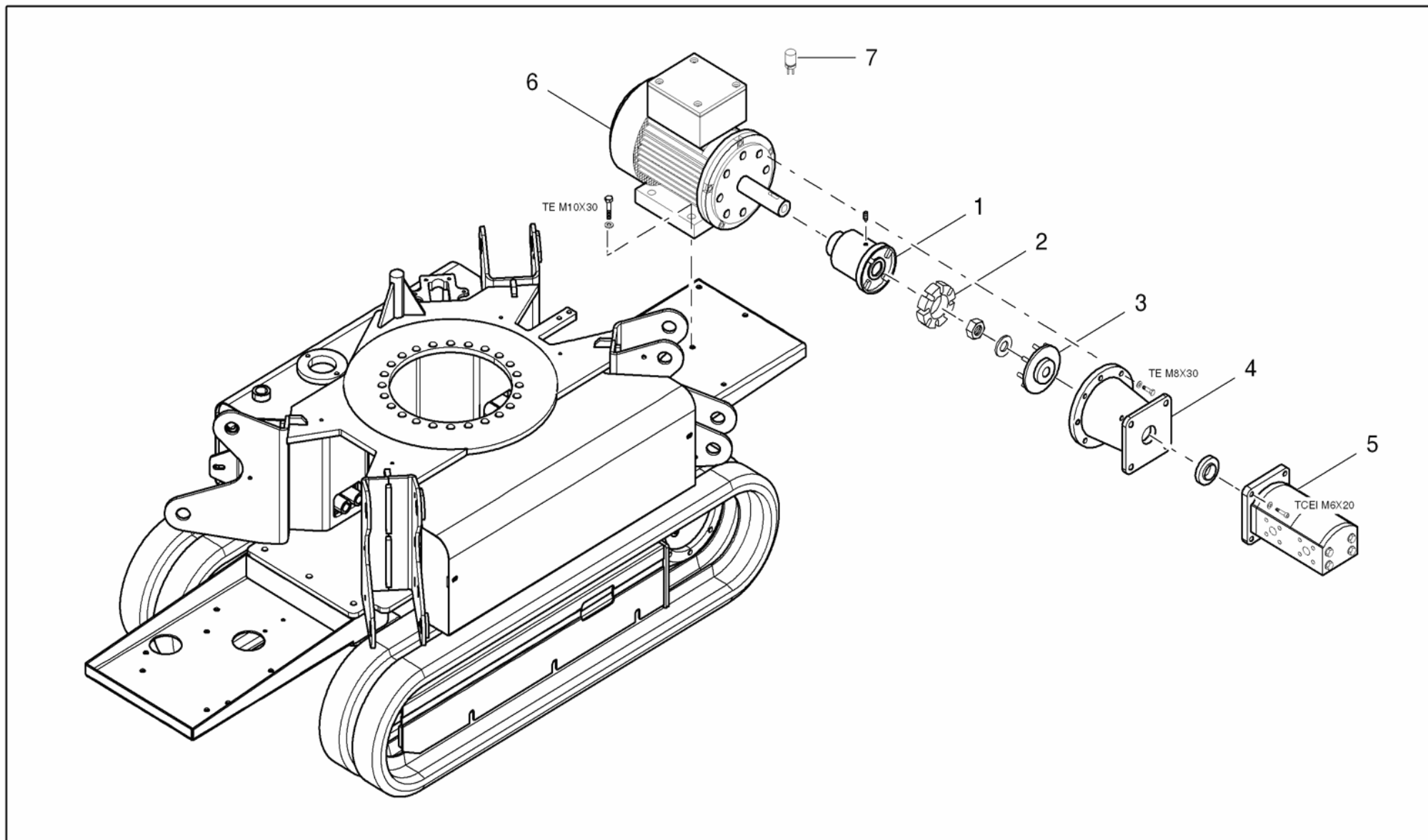

 MOTEUR ÉLECTRIQUE

E-MOTOR 

MOTOR ELÉCTRICO 



 MOTORE ELETTRICO
E-MOTOR 
 ELECTRIC MOTOR
MOTOR ELÉCTRICO 
 MOTEUR ÉLECTRIQUE

POS Codice	Q.tà	 Descrizione	 Description	 Designation	 Benennung	 Descripción
1 05563400	1 NR	SEMIGIUNTO VERSIONE MOTORE ELETTRICO STANDARD	HALF COUPLING ELECTRIC MOTOR STANDARD VERSION	DEMI-JOINT	HALBKUPPLUNG	SEMI-ACOPLAMIE NTO
2 04310100	1 NR	INSERTO IN GOMMA	RUBBER INSERT	INSERT EN CAOUTCHOUC	GUMMIEINSATZ	INSERTO DE GOMA
3 04615300	1 NR	GIUNTO	COUPLING	JOINT	VERBINDUNG	ACOPLAMIENTO
4 05510200	1 NR	LANTERNA	LANTERN	LANTERNE	LATERNE	LINTERNA
5 255263H3	1 NR	POMPA IDRAULICA	HYDRAULIC PUMP	POMPE HYDRAULIQUE	HYDRAULIKPUMP E	BOMBA HYDRÁULICA
5 255263H3	1 NR	POMPA IDRAULICA	HYDRAULIC PUMP	POMPE HYDRAULIQUE	HYDRAULIKPUMP E	BOMBA HYDRÁULICA
6 27691100	1 NR	MOTORE ELETTRICO 230V 50HZ MK2 (DA C170000893)	ELECTRIC MOTOR 230V 50HZ MK2 (FROM C170000893)	MOTEUR ÉLECTRIQUE 230V 50HZ MK2 (FROM C170000893)	E-MOTOR 230V 50HZ MK2 (FROM C170000893)	MOTOR ELÉCTRICO 230V 50HZ MK2 (FROM C170000893)
7 2551010001	1 NR	CONDENSATORE 230V MF80 D=55	CONDENSER 230V MF80 D=55	CONDENSATEUR	KONDENSATOR	CONDENSADOR
7 2632830002	1 NR	CONDENSATORE PER MOTORE 120V MF160 D=60	CAPACITOR MOTOR 120V MF160 D = 60	CONDENSATEUR	KONDENSATOR	CONDENSADOR

 IMPIANTO IDRAULICO MANDATE E SCARICO

HYDRAULIKANLAGE VORLÄUFE UND RÜCKLAUF 

 SUPPLY AND DISCHARGE HYDRAULIC SYSTEM

INSTALACIÓN HIDRÁULICA IMPULSIONES Y DESCARGA 



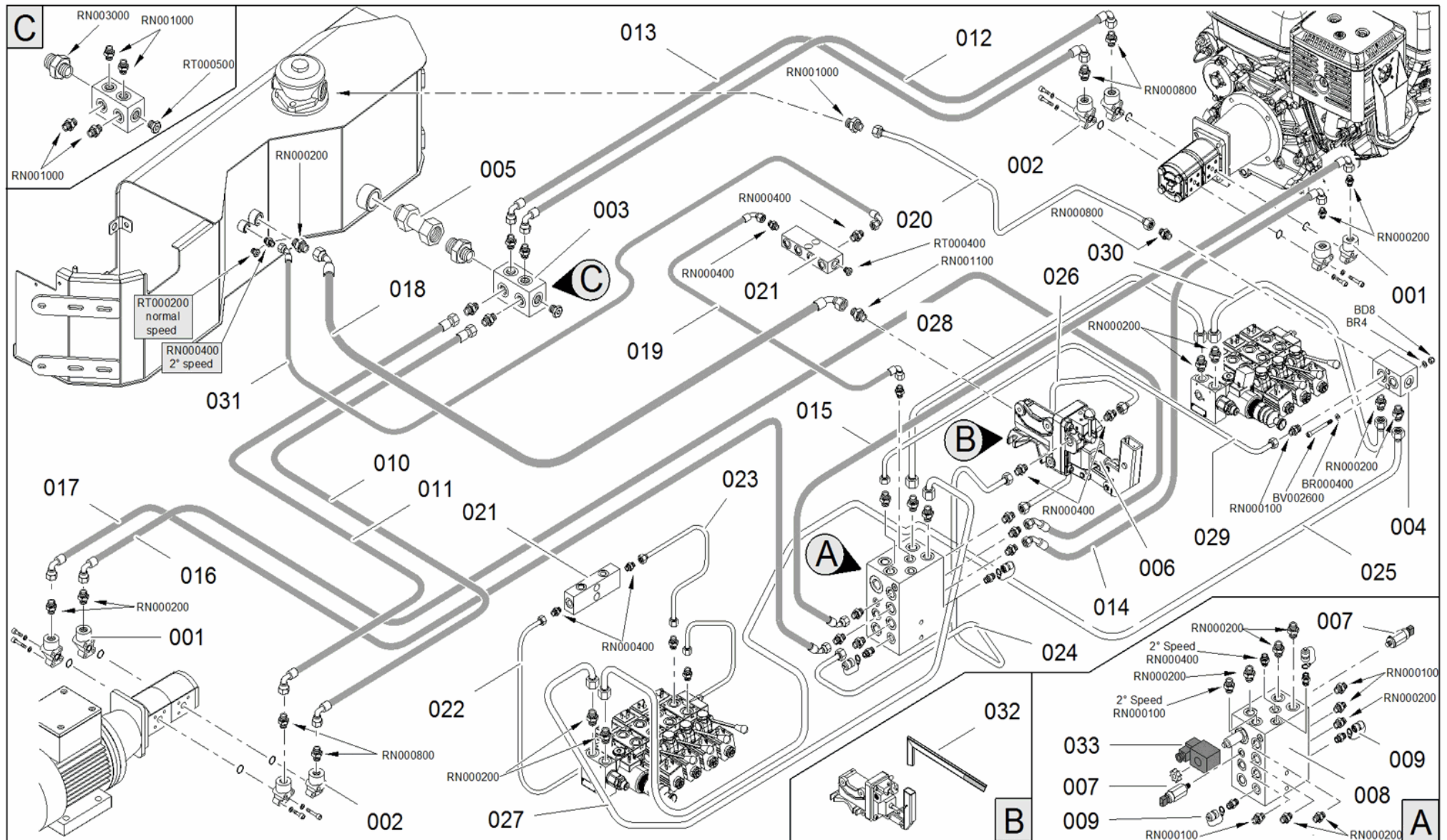

 SYSTÈME HYDRAULIQUE REFOULEMENT ET DÉCHARGEME







 IMPIANTO IDRAULICO MANDATE E SCARICO

 HYDRAULIKANLAGE VORLÄUFE UND RÜCKLAUF 
 SUPPLY AND DISCHARGE HYDRAULIC SYSTEM

 INSTALACIÓN HIDRÁULICA IMPULSIONES Y DESCARGA 
 SYSTÈME HYDRAULIQUE REFOULEMENT ET DÉCHARGEME

POS	Codice	Q.tà	 Descrizione	 Description	 Designation	 Benennung	 Descripción
1	04048100	2 NR	FLANGIA 3/8" G	FLANGE 3/8" G	BRIDE 3/8" G	FLANSCH 3/8" G	BRIDA 3/8" G
1	04048100	2 NR	FLANGIA 3/8" G	FLANGE 3/8" G	BRIDE 3/8" G	FLANSCH 3/8" G	BRIDA 3/8" G
2	04845400	2 NR	FLANGIA 1/2"G	FLANGE 1/2"G	BRIDE 1/2"G	FLANSCH 1/2"G	BRIDA 1/2"G
2	04845400	2 NR	FLANGIA 1/2"G	FLANGE 1/2"G	BRIDE 1/2"G	FLANSCH 1/2"G	BRIDA 1/2"G
3	07764900	1 NR	COLLETTORE ASPIRAZIONI POMPE LL1570	INTAKE MANIFOLD PUMPS LL1570	COLLECTEUR	KOLLEKTOR	COLECTOR
4	05497500	1 NR	BLOCCHETTO TUBI	HOSES BLOCK	BLOC TUYAUX	ROHRBLOCK	BLOQUE TUBOS
6	26459400	1 NR	POMPA A MANO	HAND PUMP	POMPE MANUELLE	HANDPUMPE	BOMBA DE MANO
7	26964400	2 NR	PRESSOSTATO	PRESSURE SWITCH	PRESSOSTAT	DRUCKSCHALTE R	PRESÓSTATO
8	17805400	1 NR	VALVOLA IDRAULICA	HYDRAULIC VALVE	VALVE HYDRAULIQUE	HYDRAULIKVENTI L	VÁLVULA HIDRÁULICA
9	03014400	2 NR	PROVA PRESSIONE 1/4" G	PRESSURE TEST 1/4" G	PREUVE PRESSION 1/4" G	DRUCKKONTROL LE 1/4" G	PRUEBA PRESIÓN 1/4" G
10	07781100	1 NR	TUBO FLESSIBILE	FLEXIBLE PIPE	TUYAU FLEXIBLE	SCHLAUCH	TUBO FLEXIBLE
11	07781200	1 NR	TUBO FLESSIBILE	FLEXIBLE PIPE	TUYAU FLEXIBLE	SCHLAUCH	TUBO FLEXIBLE
12	07780900	1 NR	TUBO FLESSIBILE	FLEXIBLE PIPE	TUYAU FLEXIBLE	SCHLAUCH	TUBO FLEXIBLE

 IMPIANTO IDRAULICO MANDATE E SCARICO
HYDRAULIKANLAGE VORLÄUFE UND RÜCKLAUF 
 SUPPLY AND DISCHARGE HYDRAULIC SYSTEM
INSTALACIÓN HIDRÁULICA IMPULSIONES Y DESCARGA 
 SYSTÈME HYDRAULIQUE REFOULEMENT ET DÉCHARGEME

POS Codice	Q.tà	 Descrizione	 Description	 Designation	 Benennung	 Descripcìon
13 07781000	1 NR	TUBO FLESSIBILE	FLEXIBLE PIPE	TUYAU FLEXIBLE	SCHLAUCH	TUBO FLEXIBLE
14 07813300	1 NR	TUBO FLESSIBILE	FLEXIBLE PIPE	TUYAU FLEXIBLE	SCHLAUCH	TUBO FLEXIBLE
15 07813600	1 NR	TUBO FLESSIBILE	FLEXIBLE PIPE	TUYAU FLEXIBLE	SCHLAUCH	TUBO FLEXIBLE
16 07813400	1 NR	TUBO FLESSIBILE	FLEXIBLE PIPE	TUYAU FLEXIBLE	SCHLAUCH	TUBO FLEXIBLE
17 07813500	1 NR	TUBO FLESSIBILE	FLEXIBLE PIPE	TUYAU FLEXIBLE	SCHLAUCH	TUBO FLEXIBLE
18 07784000	1 NR	TUBO FLESSIBILE	FLEXIBLE PIPE	TUYAU FLEXIBLE	SCHLAUCH	TUBO FLEXIBLE
20 07773000	1 NR	TUBO RIGIDO	RIGID PIPE	TUYAU	SCHLAUCH	TUBO
22 07747400	1 NR	TUBO RIGIDO	RIGID PIPE	TUYAU	ROHR	TUBO
23 07747300	1 NR	TUBO RIGIDO	RIGID PIPE	TUYAU	ROHR	TUBO
24 07772700	1 NR	TUBO RIGIDO	RIGID PIPE	TUYAU	SCHLAUCH	TUBO
25 07772300	1 NR	TUBO RIGIDO	RIGID PIPE	TUYAU	SCHLAUCH	TUBO
26 07772800	1 NR	TUBO RIGIDO	RIGID PIPE	TUYAU	SCHLAUCH	TUBO
27 07772500	1 NR	TUBO RIGIDO	RIGID PIPE	TUYAU	SCHLAUCH	TUBO
28 07772600	1 NR	TUBO RIGIDO	RIGID PIPE	TUYAU	SCHLAUCH	TUBO
29 07772900	1 NR	TUBO RIGIDO	RIGID PIPE	TUYAU	SCHLAUCH	TUBO
30 07772400	1 NR	TUBO RIGIDO	RIGID PIPE	TUYAU	SCHLAUCH	TUBO

 IMPIANTO IDRAULICO MANDATE E SCARICOHYDRAULIKANLAGE VORLÄUFE UND RÜCKLAUF  SUPPLY AND DISCHARGE HYDRAULIC SYSTEMINSTALACIÓN HIDRÁULICA IMPULSIONES Y DESCARGA  SYSTÈME HYDRAULIQUE REFOULEMENT ET DÉCHARGEME

POS Codice	Q.tà	 Descrizione	 Description	 Designation	 Benennung	 Descripcìon
32 16517700	1	NR LEVA	LEVER	LEVIER	HEBEL	PALANCA

 IMPIANTO IDRAULICO MANDATE E SCARICO

 SUPPLY AND DISCHARGE HYDRAULIC SYSTEM



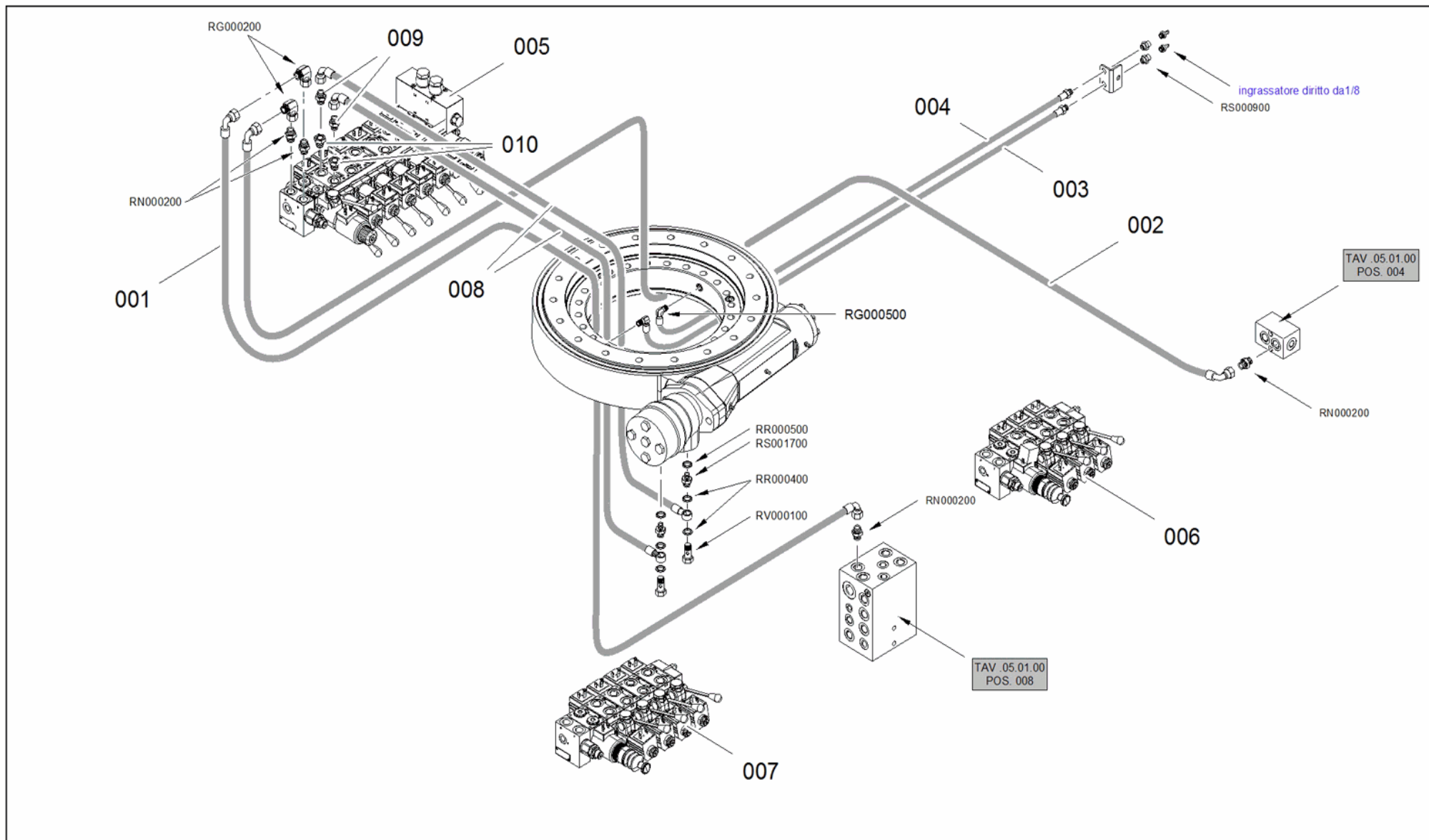

 SYSTÈME HYDRAULIQUE REFOULEMENT ET DÉCHARGEMENT

HYDRAULIKANLAGE VORLÄUFE UND RÜCKLAUF 

INSTALCIÓN HIDRÁULICA IMPULSIONES Y DESCARGA 



 IMPIANTO IDRAULICO MANDATE E SCARICO
HYDRAULIKANLAGE VORLÄUFE UND RÜCKLAUF 
 SUPPLY AND DISCHARGE HYDRAULIC SYSTEM
INSTALACIÓN HIDRÁULICA IMPULSIONES Y DESCARGA 
 SYSTÈME HYDRAULIQUE REFOULEMENT ET DÉCHARGEMENT

POS Codice	Q.tà	 Descrizione	 Description	 Designation	 Benennung	 Descripción
1 07813900	1 NR	TUBO FLESSIBILE	FLEXIBLE PIPE	TUYAU FLEXIBLE	SCHLAUCH	TUBO FLEXIBLE
2 07813800	1 NR	TUBO FLESSIBILE	FLEXIBLE PIPE	TUYAU FLEXIBLE	SCHLAUCH	TUBO FLEXIBLE
3 07784100	1 NR	TUBO FLESSIBILE	FLEXIBLE PIPE	TUYAU FLEXIBLE	SCHLAUCH	TUBO FLEXIBLE
4 07784200	1 NR	TUBO FLESSIBILE	FLEXIBLE PIPE	TUYAU FLEXIBLE	SCHLAUCH	TUBO FLEXIBLE
5 27533400	1 NR	DISTRIBUTORE IDRAULICO 7 ELEMENTI PARTE AEREA CON PULSANTE (FOR LL1775-X17JP-X5 00AJ-LL2010-X20 JP-X600AJ MK2 FROM C170000893)	HYDRAULIC DISTRIBUTOR 7 ELEMENTS AERIAL PART WITH BUTTON (FOR LL1775-X17JP-X5 00AJ-LL2010-X20 JP-X600AJ MK2 FROM C170000893)	DISTRIBUTEUR HYDRAULIQUE (FOR LL1775-X17JP-X5 00AJ-LL2010-X20 JP-X600AJ MK2 FROM C170000893)	HYDRAULISCHER VERTEILER (FOR LL1775-X17JP-X5 00AJ-LL2010-X20 JP-X600AJ MK2 FROM C170000893)	DISTRIBUIDOR HIDRÁULICO (FOR LL1775-X17JP-X5 00AJ-LL2010-X20 JP-X600AJ MK2 FROM C170000893)
6 27299000	1 NR	DISTRIBUTORE LC STABILIZZATORI-T RAINO 3 ELEMENTI CON LEVE EMERGENZA A PULSANTE	HYDRAULIC DISTRIBUTOR STABILIZERS-TRA CKS 3 PARTS WITH LEVERS EMERGENCY BUTTON	DISTRIBUTEUR HYDRAULIQUE	HYDR. REGELSTEUERG ERÄT	DISTRIBUIDOR HIDRÁULICO





 IMPIANTO IDRAULICO MANDATE E SCARICO

HYDRAULIKANLAGE VORLÄUFE UND RÜCKLAUF 

 SUPPLY AND DISCHARGE HYDRAULIC SYSTEM

INSTALACIÓN HIDRÁULICA IMPULSIONES Y DESCARGA 

 SYSTÈME HYDRAULIQUE REFOULEMENT ET DÉCHARGEMENT

POS Codice	Q.tà	 Descrizione	 Description	 Designation	 Benennung	 Descripción
7 27299100	1 NR	DISTRIBUTORE LC STABILIZZATORI-T RAINO 4 ELEMENTI CON LEVE EMERGENZA A PULSANTE	HYDRAULIC DISTRIBUTOR STABILIZERS-TRA CKS 4 PARTS WITH LEVERS EMERGENCY BUTTON	DISTRIBUTEUR HYDRAULIQUE	HYDRAULIKVENTI LBLOCK	DISTRIBUIDOR HIDRÁULICO
8 07784500	2 NR	TUBO FLESSIBILE	FLEXIBLE PIPE	TUYAU FLEXIBLE	SCHLAUCH	TUBO FLEXIBLE
9 06786700	2 NR	RACCORDO	FITTING	RACCORD	ANSCHLUSS	CONEXIÓN
10 RS000700	2 NR	RIDUZIONE M-F GAS 1" * 1/2"	REDUCING GAS M-F 1 " * 1/2"	RÉDUCTION M-F GAS 1" * 1/2"	REDUZIERUNG GAS M-F 1"* 1/2"	REDUCCIÓN M-F GAS 1" * 1/2"

 DISTRIBUTORI IDRAULICI

 HYDRAULIC DISTRIBUTORS



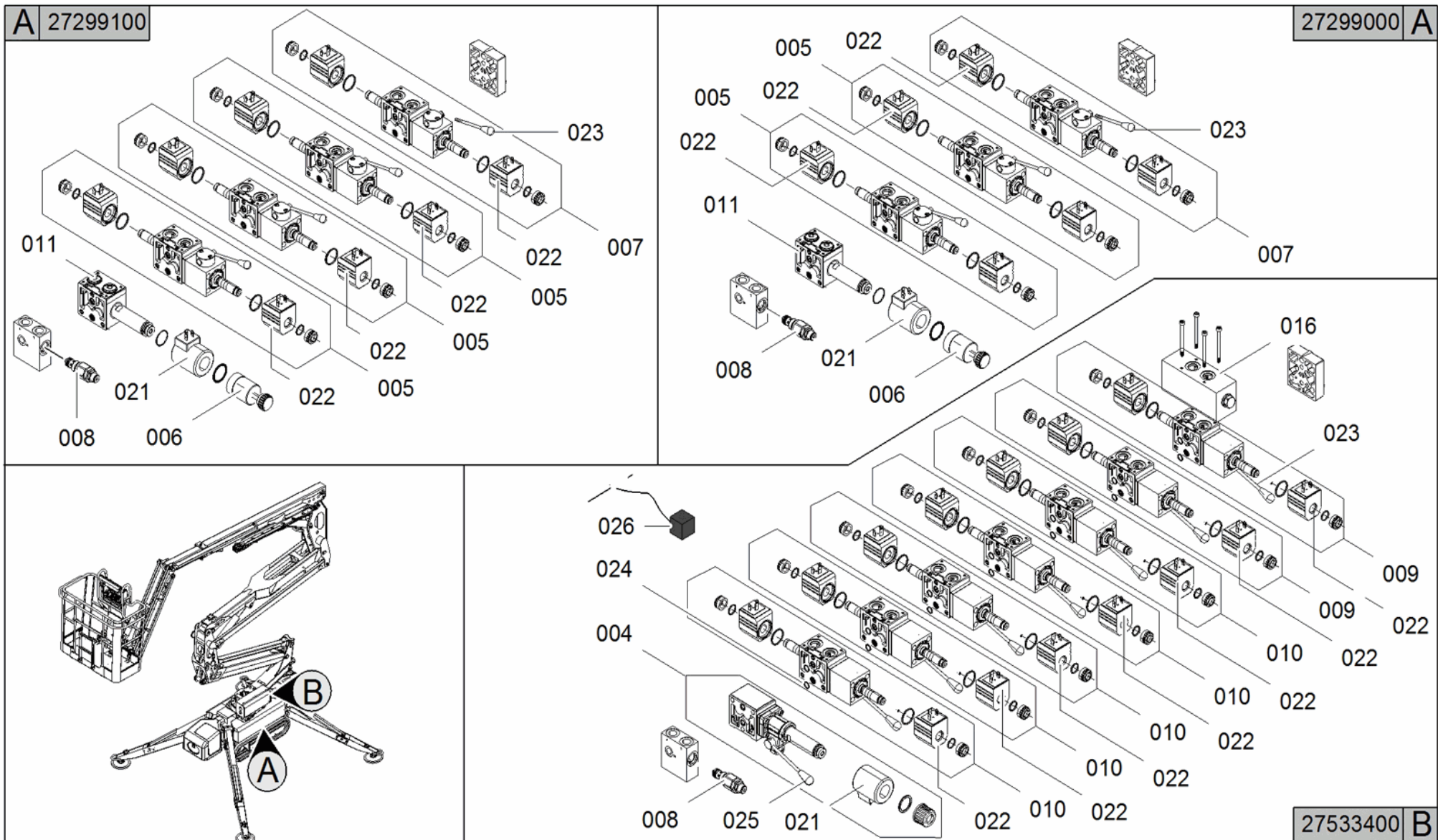

 DISTRIBUTEURS HYDRAULIQUES

HYDRAULISCHE REGELSTEUERGERÄTE 





DISTRIBUIDORES HIDRÁULICOS 







 DISTRIBUTORI IDRAULICIHYDRAULISCHE REGELSTEUERGERÄTE  HYDRAULIC DISTRIBUTORSDISTRIBUIDORES HIDRÁULICOS  DISTRIBUTEURS HYDRAULIQUES

POS Codice	Q.tà	 Descrizione	 Description	 Designation	 Benennung	 Descripción
4 2753340004	1 NR	ELEMENTO DISTRIBUTORE COMPLETO DI PROPORZIONALE PARTE AEREA CON LEVA ROSSA (LATO 1)	VALVE BLOCK ELEMENT	ELEMENT DISTRIBUTEUR	VENTILBLOCKSA TZ	ELEMENTO DISTRIBUIDOR
5 2645900005	1 NR	SEZIONE DISTRIBUTORE AB CHIUSO CON LEVA (LATO A) E BOBINA	VALVE BLOCK SECTION AB CLOSED WITH LEVER (SIDE A) AND COIL	SECTION DISTRIBUTEUR	VENTILBLOCKSE KTION	SECCIÓN DISTRIBUIDOR
5 2645900005	1 NR	SEZIONE DISTRIBUTORE AB CHIUSO CON LEVA (LATO A) E BOBINA	VALVE BLOCK SECTION AB CLOSED WITH LEVER (SIDE A) AND COIL	SECTION DISTRIBUTEUR	VENTILBLOCKSE KTION	SECCIÓN DISTRIBUIDOR
6 07324900	1 NR	COMANDO MANUALE EMERGENZA CON RITORNO A MOLLA	EMERGENCY MAUAL CONTROL WITH SPRING RETURN	COMMANDE MANUEL D'URGENCE	MANUELLES ANTRIEB FÜR NOTSTAND	MANDO MANUAL DE EMERGENCIA
6 07324900	1 NR	COMANDO MANUALE EMERGENZA CON RITORNO A MOLLA	EMERGENCY MAUAL CONTROL WITH SPRING RETURN	COMMANDE MANUEL D'URGENCE	MANUELLES ANTRIEB FÜR NOTSTAND	MANDO MANUAL DE EMERGENCIA





 DISTRIBUTORI IDRAULICI
HYDRAULISCHE REGELSTEUERGERÄTE 
 HYDRAULIC DISTRIBUTORS
DISTRIBUIDORES HIDRÁULICOS 
 DISTRIBUTEURS HYDRAULIQUES

POS Codice	Q.tà	 Descrizione	 Description	 Designation	 Benennung	 Descripción
7 2645900006	1 NR	SEZIONE DISTRIBUTORE ABT CON LEVA (LATO A) E BOBINA	VALVE BLOCK SECTION ABT WITH LEVER (SIDE A) AND COIL	SECTION DISTRIBUTEUR	VENTILBLOCKSE KTION	SECCIÓN DISTRIBUIDOR
7 2645900006	1 NR	SEZIONE DISTRIBUTORE ABT CON LEVA (LATO A) E BOBINA	VALVE BLOCK SECTION ABT WITH LEVER (SIDE A) AND COIL	SECTION DISTRIBUTEUR	VENTILBLOCKSE KTION	SECCIÓN DISTRIBUIDOR
8 2645900002	1 NR	CARTUCCIA VALVOLA DI MASSIMA PRESSIONE	CARTRIDGE PRESSURE RELIEF VALVE	CARTOUCHE SOUPAPE DE SÉCURITÉ	PARTONE ÜBERDRUCKVEN TIL	CATUCHO VÁLVULA LIMITADORA DE PRESIÓN
8 2645900002	1 NR	CARTUCCIA VALVOLA DI MASSIMA PRESSIONE	CARTRIDGE PRESSURE RELIEF VALVE	CARTOUCHE SOUPAPE DE SÉCURITÉ	PARTONE ÜBERDRUCKVEN TIL	CATUCHO VÁLVULA LIMITADORA DE PRESIÓN
8 2645900002	1 NR	CARTUCCIA VALVOLA DI MASSIMA PRESSIONE	CARTRIDGE PRESSURE RELIEF VALVE	CARTOUCHE SOUPAPE DE SÉCURITÉ	PARTONE ÜBERDRUCKVEN TIL	CATUCHO VÁLVULA LIMITADORA DE PRESIÓN
9 2753340002	1 NR	SEZIONE DISTRIBUTORE ABT CON LEVA (LATO 1) E BOBINA	SECTION DISTRIBUTOR ABT WITH LEVER (SIDE 1) AND COIL	SECTION DISTRIBUTEUR	VENTILBLOCKSE KTION	SECCIÓN DISTRIBUIDOR

 DISTRIBUTORI IDRAULICIHYDRAULISCHE REGELSTEUERGERÄTE  HYDRAULIC DISTRIBUTORSDISTRIBUIDORES HIDRÁULICOS  DISTRIBUTEURS HYDRAULIQUES

POS Codice	Q.tà	 Descrizione	 Description	 Designation	 Benennung	 Descripción
10 2753340001	1 NR	SEZIONE DISTRIBUTORE AB CHIUSO CON LEVA (LATO 1) E BOBINA	SECTION DISTRIBUTOR AB CLOSED WITH LEVER (SIDE 1) AND COIL	SECTION DISTRIBUTEUR	VENTILBLOCKSE KTION	SECCIÓN DISTRIBUIDOR
11 2729900001	1 NR	VALVOLA PROPORZIONALE TRAINI CON BOBINA E SENZA COMANDO MANUALE A MOLLA	PROPORTIONAL VALVE FOR TRACK WITH COIL AND WITHOUT MANUAL SPRING	SOUPAPE PROPORTIONELL E	PROPORTIONALV ENTIL	VÁLVULA PROPORCIONAL
11 2729900001	1 NR	VALVOLA PROPORZIONALE TRAINI CON BOBINA E SENZA COMANDO MANUALE A MOLLA	PROPORTIONAL VALVE FOR TRACK WITH COIL AND WITHOUT MANUAL SPRING	SOUPAPE PROPORTIONELL E	PROPORTIONALV ENTIL	VÁLVULA PROPORCIONAL
16 2585560004	1 NR	BLOCCO VALVOLA BILANCIAMENTO BRACCI SU DISTRIBUTORI PARTE AEREA	BALANCING VALVE BLOCK BOOMS OF DISTRIBUTORS AERIAL PART	BLOC SOUPAPE	VENTILSPERRE	BLOQUE VÁLVULA





 DISTRIBUTORI IDRAULICIHYDRAULISCHE REGELSTEUERGERÄTE  HYDRAULIC DISTRIBUTORSDISTRIBUIDORES HIDRÁULICOS  DISTRIBUTEURS HYDRAULIQUES

POS Codice	Q.tà	 Descrizione	 Description	 Designation	 Benennung	 Descripcìon
21 06037100	1 NR	BOBINA PER VALVOLA PROPORZIONALE PARTE CARRO	COIL PROPORTIONAL VALVE FOR UNDERCARRIAGE	BOBINE	SPULE	BOBINA
21 06037100	1 NR	BOBINA PER VALVOLA PROPORZIONALE PARTE CARRO	COIL PROPORTIONAL VALVE FOR UNDERCARRIAGE	BOBINE	SPULE	BOBINA
22 05913800	1 NR	BOBINA PER ON-OFF	COIL FOR ON-OFF	BOBINE	SPULE	BOBINA
22 05913800	1 NR	BOBINA PER ON-OFF	COIL FOR ON-OFF	BOBINE	SPULE	BOBINA
22 05913800	1 NR	BOBINA PER ON-OFF	COIL FOR ON-OFF	BOBINE	SPULE	BOBINA
23 07300200	1 NR	LEVA DISTRIBUTORE	LEVER HYDRAULIC DISTRIBUTOR	LEVIER	HEBEL	PALANCA
23 07300200	1 NR	LEVA DISTRIBUTORE	LEVER HYDRAULIC DISTRIBUTOR	LEVIER	HEBEL	PALANCA
23 07300200	1 NR	LEVA DISTRIBUTORE	LEVER HYDRAULIC DISTRIBUTOR	LEVIER	HEBEL	PALANCA

 DISTRIBUTORI IDRAULICI

 HYDRAULISCHE REGELSTEUERGERÄTE 
 HYDRAULIC DISTRIBUTORS

 DISTRIBUIDORES HIDRÁULICOS 
 DISTRIBUTEURS HYDRAULIQUES

POS Codice	Q.tà	 Descrizione	 Description	 Designation	 Benennung	 Descripción
24 2585560005	1	NR O-RING	O-RING	O-RING	O-RING	O-RING
24 2585560005	1	NR O-RING	O-RING	O-RING	O-RING	O-RING
24 2585560005	1	NR O-RING	O-RING	O-RING	O-RING	O-RING
25 2753340003	1	NR LEVA ROSSA DISTRIBUTORE	RED LEVER HYDRAULIC DISTRIBUTOR	LEVIER	HEBEL	PALANCA
26 1730720001	1	NR ELETTRIVALVOL A ON-OFF CON LED	SOLENOID ON-OFF WITH LED	ELECTROVANNE ON-OFF AVEC LED	SOLENOID ON-OFF WITH LED	SOLENOIDE ON-OFF CON LED

 IMPIANTO IDRAULICO TRAZIONE

 HYDRAULIC SYSTEM FOR TRACTION

 SYSTÈME HYDRAULIQUE DE TRACTION

HYDRAULIKANLAGE ANTRIEB 

INSTALACIÓN HIDRÁULICA TRACCIÓN 

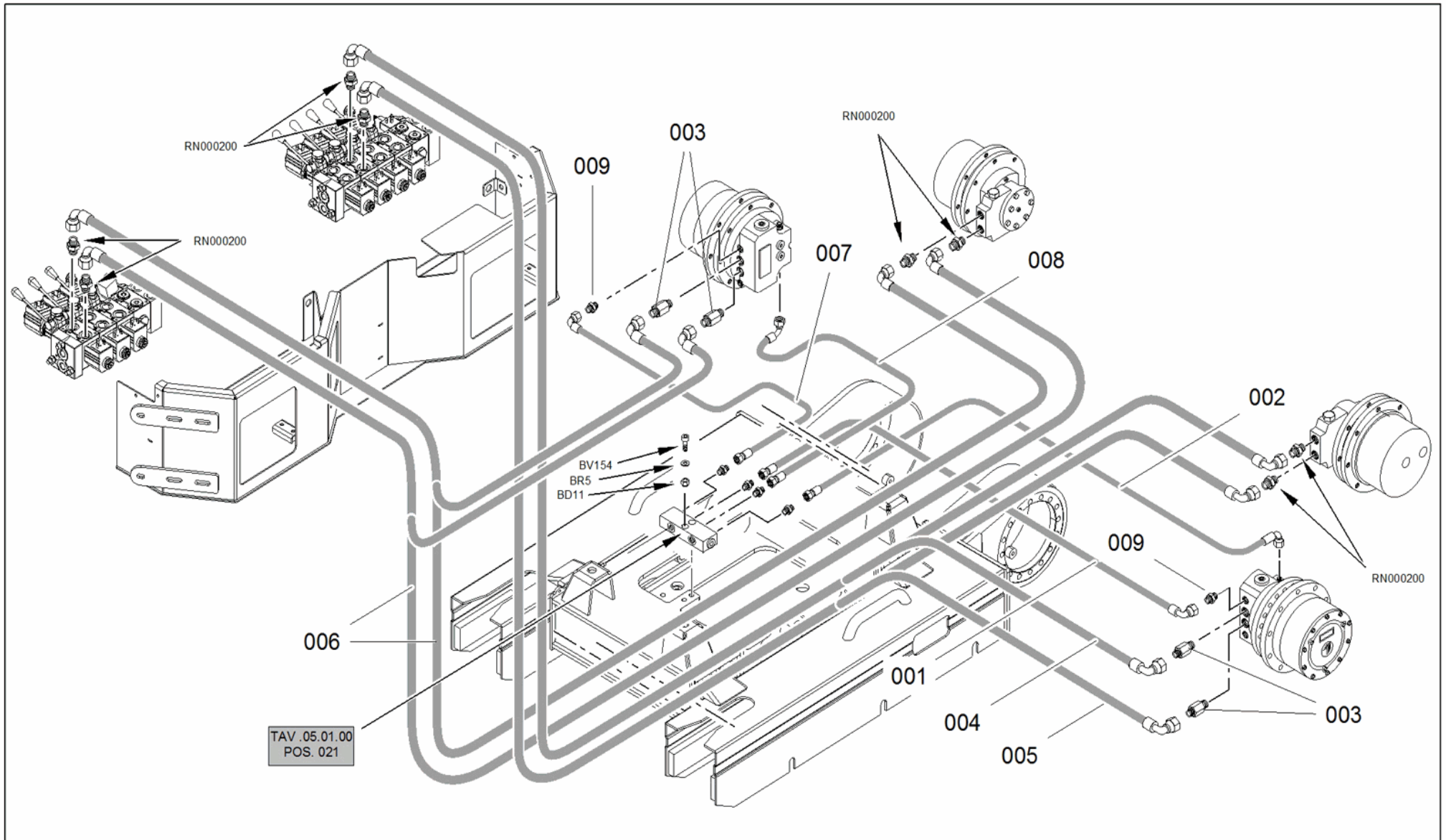





 IMPIANTO IDRAULICO TRAZIONE

HYDRAULIKANLAGE ANTRIEB 

 HYDRAULIC SYSTEM FOR TRACTION

INSTALACIÓN HIDRÁULICA TRACCIÓN 

 SYSTÈME HYDRAULIQUE DE TRACTION

POS Codice	Q.tà	 Descrizione	 Description	 Designation	 Benennung	 Descripcìon
4 07783700	1 NR	TUBO FLESSIBILE	FLEXIBLE PIPE	TUYAU FLEXIBLE	SCHLAUCH	TUBO FLEXIBLE
5 07783800	1 NR	TUBO FLESSIBILE	FLEXIBLE PIPE	TUYAU FLEXIBLE	SCHLAUCH	TUBO FLEXIBLE
6 07783900	2 NR	TUBO FLESSIBILE	FLEXIBLE PIPE	TUYAU FLEXIBLE	SCHLAUCH	TUBO FLEXIBLE

 IMPIANTO IDRAULICO ALLARGAMENTO CARRO

 HYDRAULIC SYSTEM UNDERCARRIAGE EXPANSION

 SYSTÈME HYDRAULIQUE EXTENSION DU CHARIOT

HYDRAULIKANLAGE VERBREITERUNG WAGEN 

INSTALACIÓN HIDRAULICA ENSANCHAMIENTO CARRO 

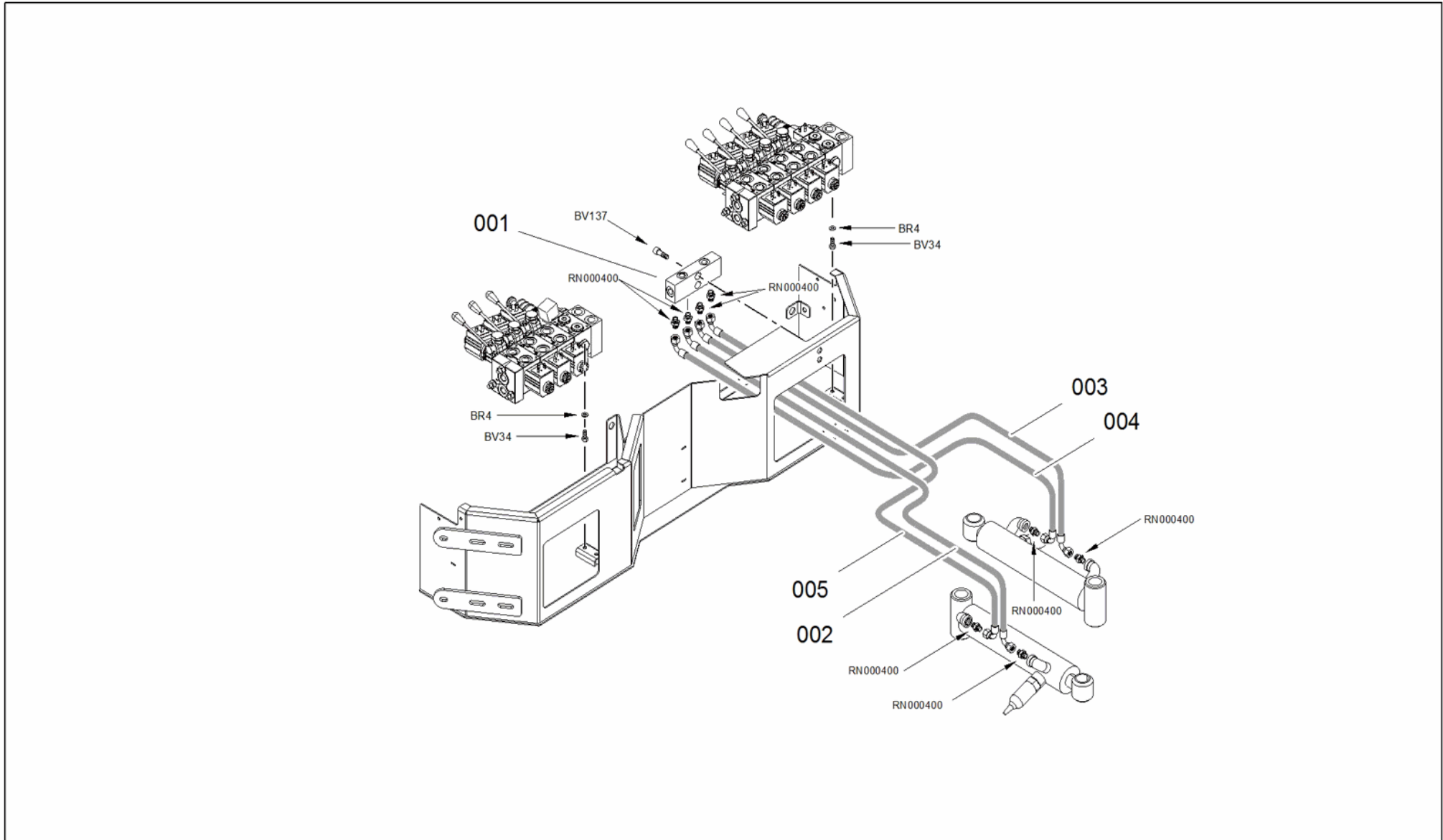





 IMPIANTO IDRAULICO ALLARGAMENTO CARRO

HYDRAULIKANLAGE VERBREITERUNG WAGEN 

 HYDRAULIC SYSTEM UNDERCARRIAGE EXPANSION

INSTALACIÓN HIDRAULICA ENSANCHAMIENTO CARRO 

 SYSTÈME HYDRAULIQUE EXTENSION DU CHARIOT

POS Codice	Q.tà	 Descrizione	 Description	 Designation	 Benennung	 Descripción
1 04707700	1 NR	COLLETTORE	MANIFOLD	COLLECTEUR	KOLLEKTOR	COLECTOR
2 07783500	1 NR	TUBO FLESSIBILE	FLEXIBLE PIPE	TUYAU FLEXIBLE	SCHLAUCH	TUBO FLEXIBLE
3 07783600	1 NR	TUBO FLESSIBILE	FLEXIBLE PIPE	TUYAU FLEXIBLE	SCHLAUCH	TUBO FLEXIBLE
4 07783300	1 NR	TUBO FLESSIBILE	FLEXIBLE PIPE	TUYAU FLEXIBLE	SCHLAUCH	TUBO FLEXIBLE
5 07783400	1 NR	TUBO FLESSIBILE	FLEXIBLE PIPE	TUYAU FLEXIBLE	SCHLAUCH	TUBO FLEXIBLE

 IMPIANTO IDRAULICO STABILIZZATORI

 STABILIZERS HYDRAULIC SYSTEM

 INSTALLATION HYDRAULIQUE STABILISATERS

ABSTÜTZUNG ABSTÜTZUNGSHYDRAULIKZYLIND 



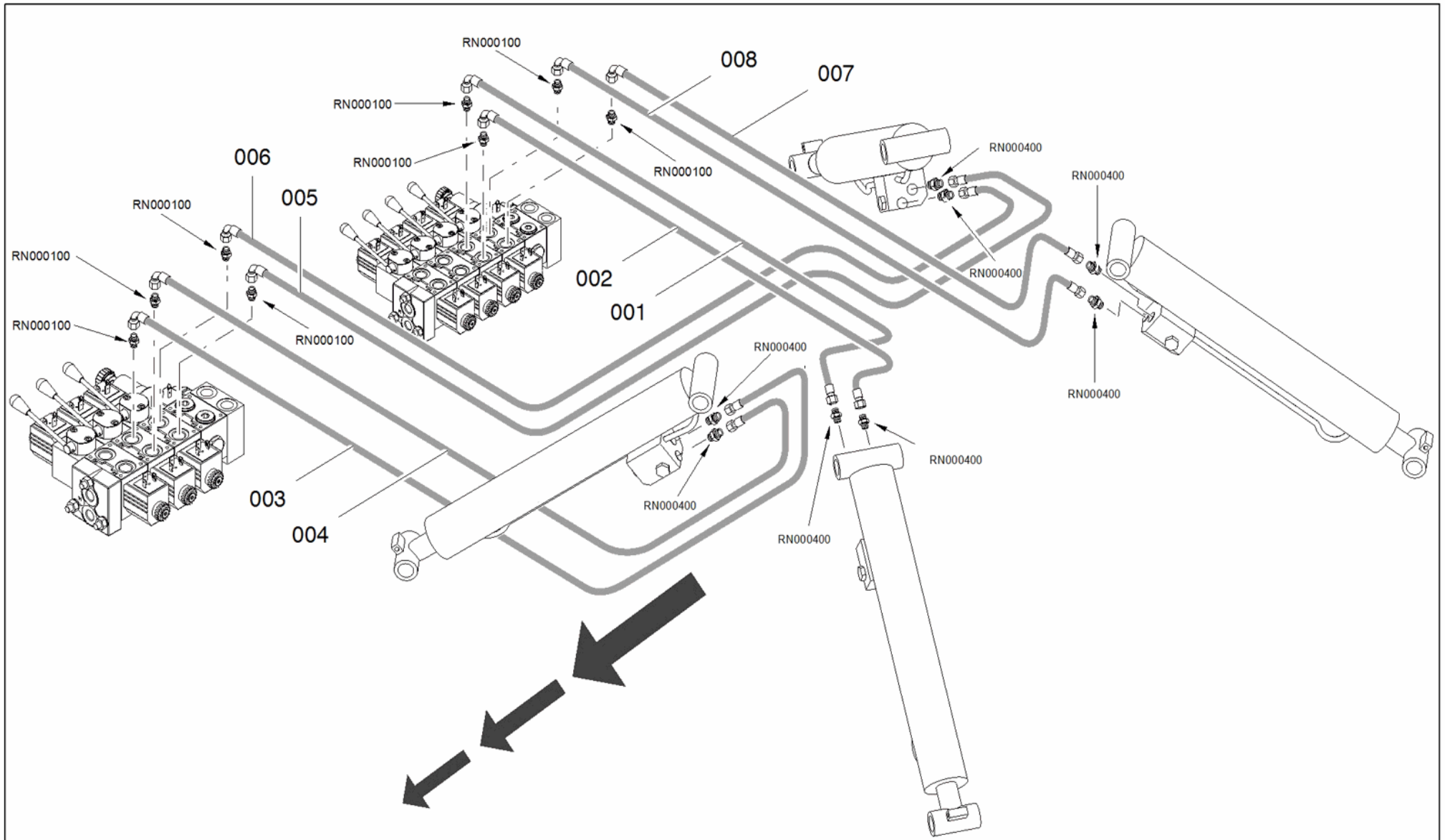

INSTALACIÓN HIDRAULICA ESTABILIZADORS 



 IMPIANTO IDRAULICO STABILIZZATORI

 ABSTÜTZUNG ABSTÜTZUNGSHYDRAULIKZYLIND 
 STABILIZERS HYDRAULIC SYSTEM

 INSTALACIÓN HIDRAULICA ESTABILIZADORS 
 INSTALLATION HYDRAULIQUE STABILISATERS

POS Codice	Q.tà	 Descrizione	 Description	 Designation	 Benennung	 Descripcìon
1 07782200	1 NR	TUBO FLESSIBILE	FLEXIBLE PIPE	TUYAU FLEXIBLE	SCHLAUCH	TUBO FLEXIBLE
2 07782100	1 NR	TUBO FLESSIBILE	FLEXIBLE PIPE	TUYAU FLEXIBLE	SCHLAUCH	TUBO FLEXIBLE
3 07781700	1 NR	TUBO FLESSIBILE	FLEXIBLE PIPE	TUYAU FLEXIBLE	SCHLAUCH	TUBO FLEXIBLE
4 07781800	1 NR	TUBO FLESSIBILE	FLEXIBLE PIPE	TUYAU FLEXIBLE	SCHLAUCH	TUBO FLEXIBLE
5 07781900	1 NR	TUBO FLESSIBILE	FLEXIBLE PIPE	TUYAU FLEXIBLE	SCHLAUCH	TUBO FLEXIBLE
6 07782000	1 NR	TUBO FLESSIBILE	FLEXIBLE PIPE	TUYAU FLEXIBLE	SCHLAUCH	TUBO FLEXIBLE
7 07782400	1 NR	TUBO FLESSIBILE	FLEXIBLE PIPE	TUYAU FLEXIBLE	SCHLAUCH	TUBO FLEXIBLE
8 07782300	1 NR	TUBO FLESSIBILE	FLEXIBLE PIPE	TUYAU FLEXIBLE	SCHLAUCH	TUBO FLEXIBLE

 IMPIANTO IDRAULICO 1-2 BRACCI

 1-2 ARMS HYDRAULIC SYSTEM



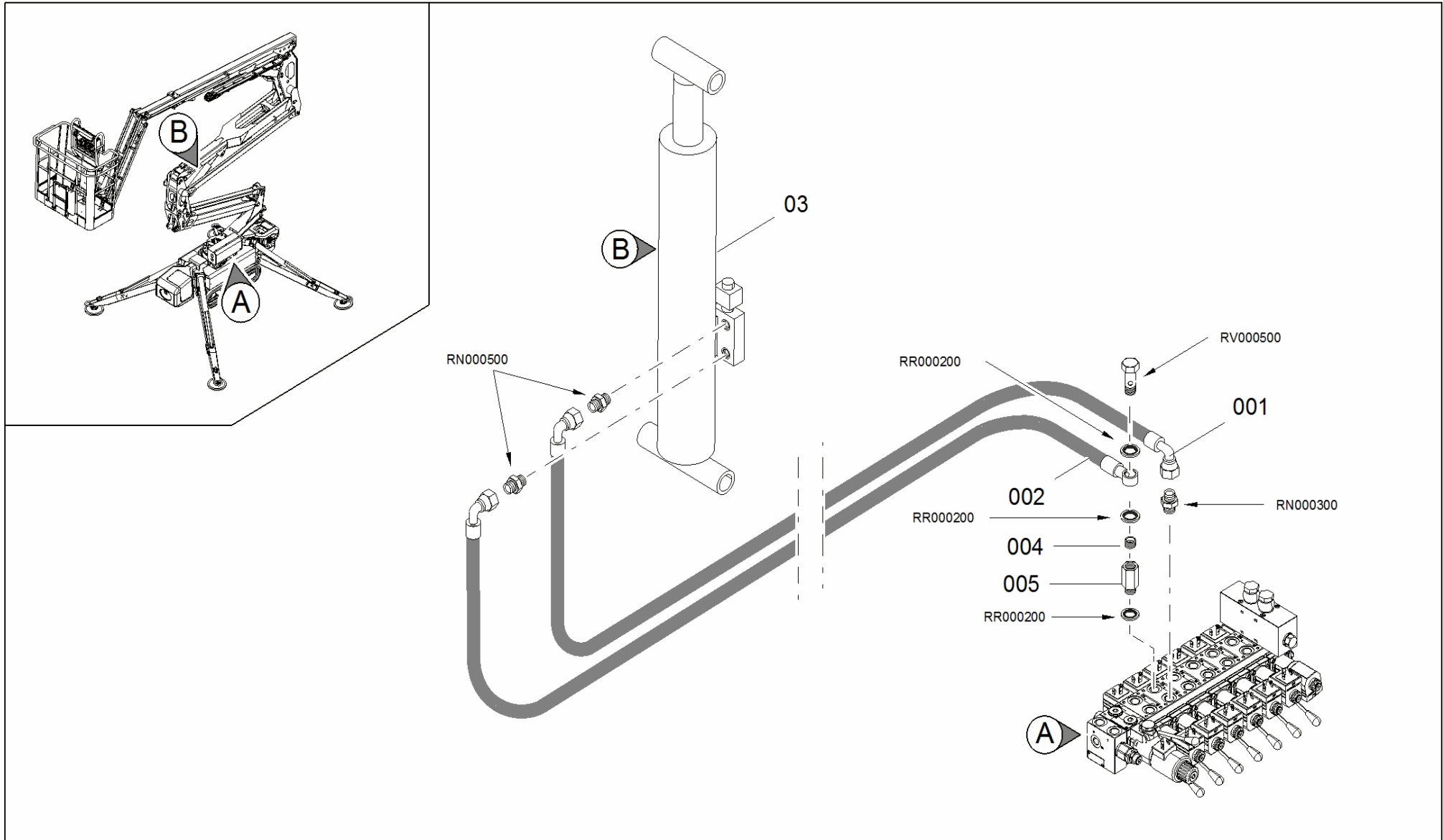

 SYSTÈME HYDRAULIQUE 1-2 BRAS

HYDRAULIKANLAGE 1-2 ARM 

INSTALACIÓN HIDRÁULICA 1-2 BRAZOS 



 IMPIANTO IDRAULICO 1-2 BRACCI
HYDRAULIKANLAGE 1-2 ARM 
 1-2 ARMS HYDRAULIC SYSTEM
INSTALACIÓN HIDRÁULICA 1-2 BRAZOS 
 SYSTÈME HYDRAULIQUE 1-2 BRAS

POS Codice	Q.tà	 Descrizione	 Description	 Designation	 Benennung	 Descripción
1 07784600	1 NR	TUBO FLESSIBILE	FLEXIBLE PIPE	TUYAU FLEXIBLE	SCHLAUCH	TUBO FLEXIBLE
2 07784700	1 NR	TUBO FLESSIBILE	FLEXIBLE PIPE	TUYAU FLEXIBLE	SCHLAUCH	TUBO FLEXIBLE
3 277099H2	1 NR	CILINDRO PRIMO-SECONDO BRACCIO LL1570-X15JP-X4 30AJ	CYLINDER FIRST-SECOND BOOM LL1570-X15JP-X4 30AJ	CYLINDER	ZYLINDER	CILINDRO
4 07688500	1 NR	PASTIGLIA VNR STROZZATA 3/8 FORO DA Ø=2MM	VALVE	SOUPAPE	VENTIL	VALVULA
5 07688400	1 NR	RACCORDO PROLUNGA M-F 3/8 H=30 FILETTO UTILE 25	FITTING	RACCORD	ANSCHLUSS	CONEXIÓN

 IMPIANTO IDRAULICO 3 BRACCIO

 3 ARM HYDRAULIC SYSTEM

 SYSTÈME HYDRAULIQUE 3 BRAS

HYDRAULIKANLAGE 3 ARM 

INSTALACIÓN HIDRÁULICA 3 BRAZO 

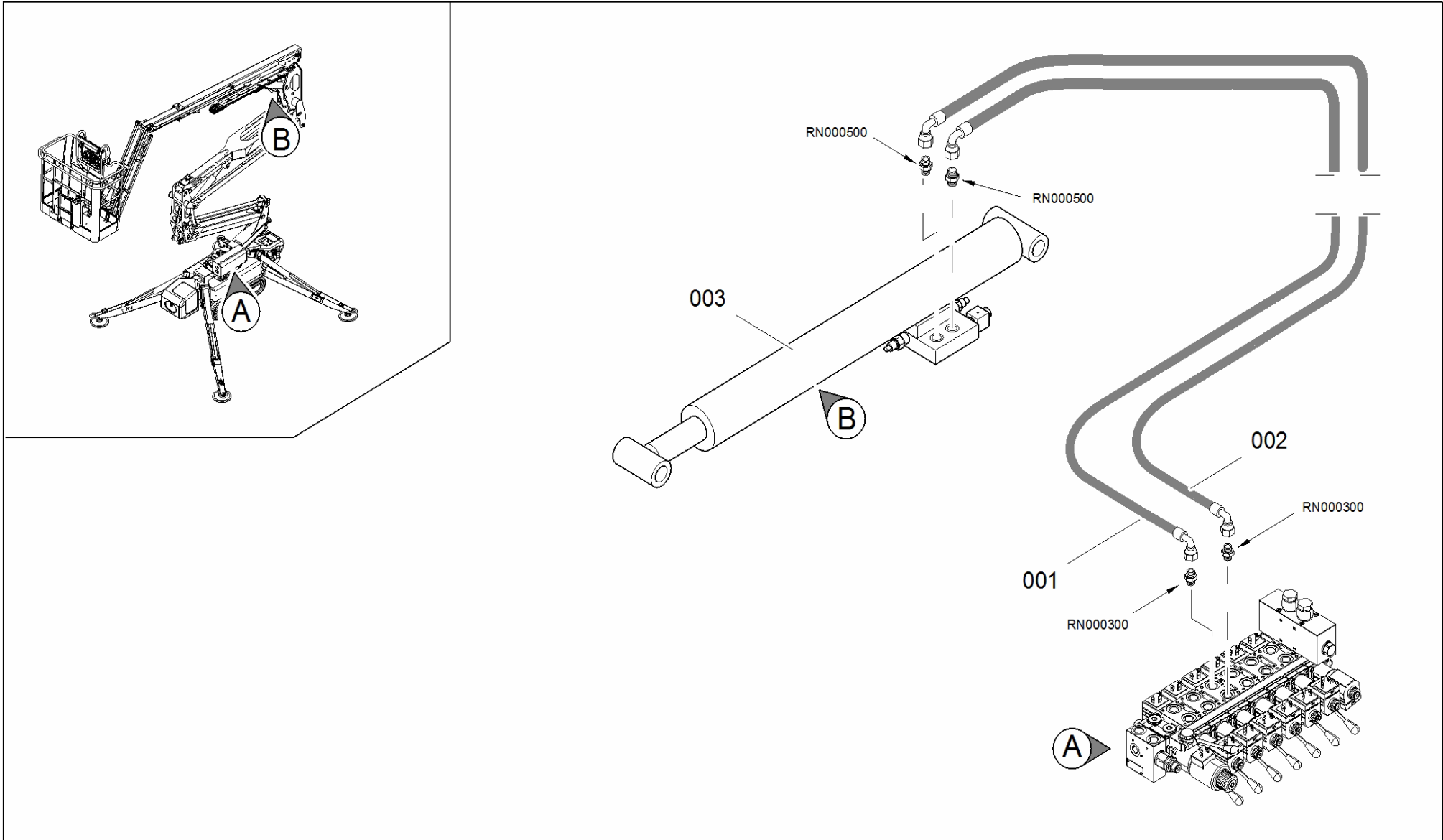





 IMPIANTO IDRAULICO 3 BRACCIO

HYDRAULIKANLAGE 3 ARM 

 3 ARM HYDRAULIC SYSTEM

INSTALACIÓN HIDRÁULICA 3 BRAZO 

 SYSTÈME HYDRAULIQUE 3 BRAS

POS Codice	Q.tà	 Descrizione	 Description	 Designation	 Benennung	 Descripcìon
1 07785000	1 NR	TUBO FLESSIBILE	FLEXIBLE PIPE	TUYAU FLEXIBLE	SCHLAUCH	TUBO FLEXIBLE
2 07785100	1 NR	TUBO FLESSIBILE	FLEXIBLE PIPE	TUYAU FLEXIBLE	SCHLAUCH	TUBO FLEXIBLE
3 277100H2	1 NR	CILINDRO TERZO BRACCIO LL1570-X15JP-X4 30AJ	THIRD CYLINDER BOOM LL1570-X15JP-X4 30AJ	CYLINDRE TROISIÈME BRAS	ZYLINDER DRITTER ARM	CILINDRO TERCERO BRAZO





 IMPIANTO IDRAULICO SFILO

TELESKOPHYDRAULIK 

 TELESCOPIC HYDRAULIC SYSTEM

INSTALACIÓN EXTENSIÓN HIDRÁULICA 

 TELESCOPIQUE HIDRAULIQUE

POS Codice	Q.tà	 Descrizione	 Description	 Designation	 Benennung	 Descripcìon
1 07785200	1 NR	TUBO FLESSIBILE	FLEXIBLE PIPE	TUYAU FLEXIBLE	SCHLAUCH	TUBO FLEXIBLE
2 07785300	1 NR	TUBO FLESSIBILE	FLEXIBLE PIPE	TUYAU FLEXIBLE	SCHLAUCH	TUBO FLEXIBLE
3 07753700	1 NR	TUBO RIGIDO	RIGID PIPE	TUYAU	SCHLAUCH	TUBO
4 07753800	1 NR	TUBO RIGIDO	RIGID PIPE	TUYAU	SCHLAUCH	TUBO
5 277101H2	1 NR	CILINDRO SFILO LL1570	CYLINDER EXTENSION LL1570	CYLINDRE	ZYLINDER	CILINDRO

 IMPIANTO JIB

 JIB HYDRAULIC SYSTEM



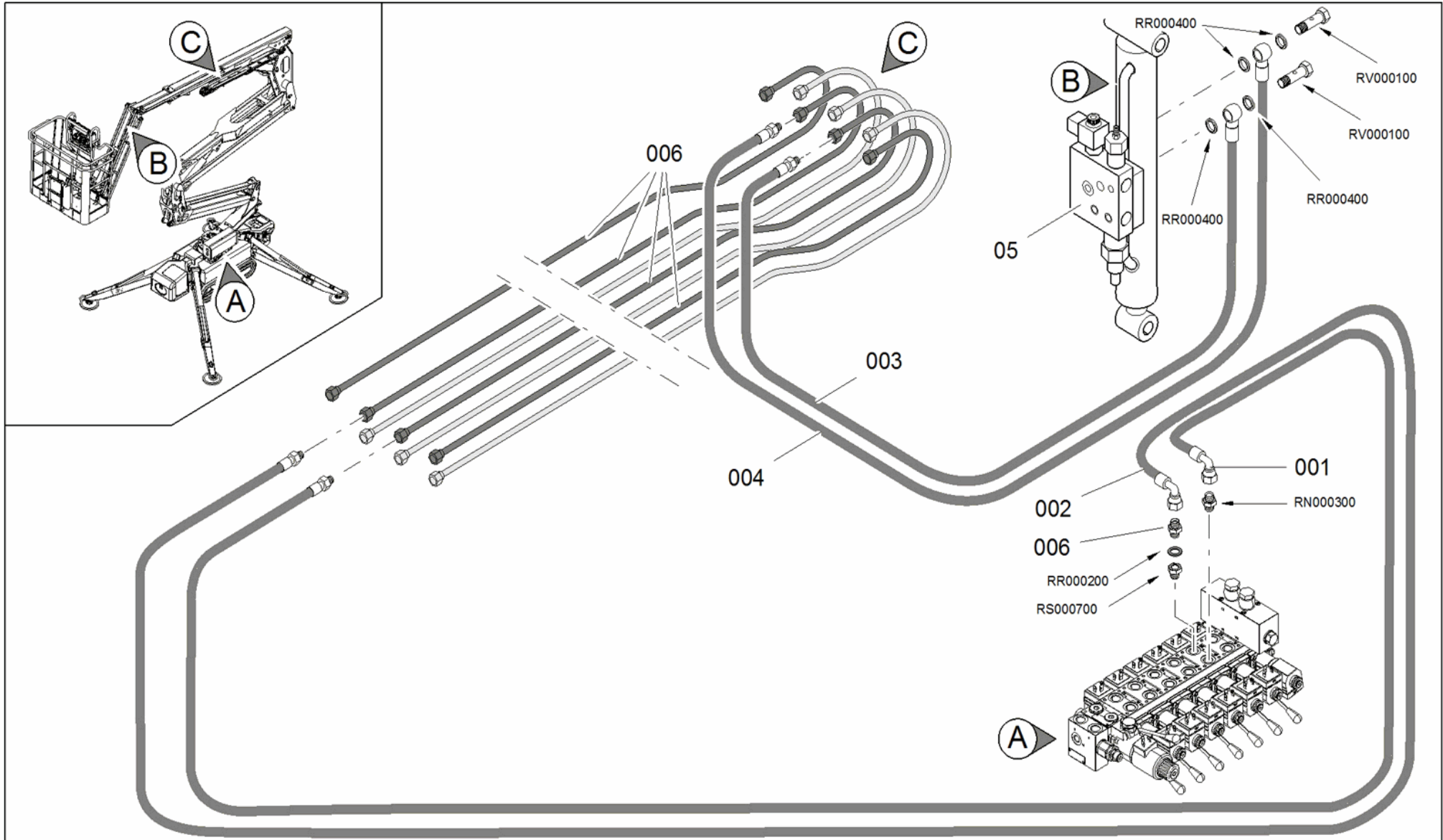

 SYSTÈME HYDRAULIQUE JIB

ZYLINDER JIB ARM 

INSTALACIÓN HIDRÁULICA JIB 



 IMPIANTO JIBZYLINDER JIB ARM  JIB HYDRAULIC SYSTEMINSTALACIÓN HIDRÁULICA JIB  SYSTÈME HYDRAULIQUE JIB

POS Codice	Q.tà	 Descrizione	 Description	 Designation	 Benennung	 Descripción
1 07785700	1 NR	TUBO FLESSIBILE	FLEXIBLE PIPE	TUYAU FLEXIBLE	SCHLAUCH	TUBO FLEXIBLE
2 07785600	1 NR	TUBO FLESSIBILE	FLEXIBLE PIPE	TUYAU FLEXIBLE	SCHLAUCH	TUBO FLEXIBLE
3 07786400	1 NR	TUBO FLESSIBILE	FLEXIBLE PIPE	TUYAU FLEXIBLE	SCHLAUCH	TUBO FLEXIBLE
4 07786300	1 NR	TUBO FLESSIBILE	FLEXIBLE PIPE	TUYAU FLEXIBLE	SCHLAUCH	TUBO FLEXIBLE
5 270695H2	1 NR	CILINDRO JIB	JIB CYLINDER	CYLINDRE JIB	KORBARMZYLINDER	CILINDRO JIB
6 07753900	4 NR	TUBO RIGIDO	RIGID PIPE	TUYAU	SCHLAUCH	TUBO

 IMPIANTO IDRAULICO LIVELLAMENTO

 LEVELING CYLINDERS HYDRAULIC SYSTEM

 SYSTÈME HYDRAULIQUE CYLINDRES BRAS

HYDRAULIKANLAGE ZYLINDER ARM 

INSTALACIÓN HIDRÁULICA CILINDROS BRAZOS 

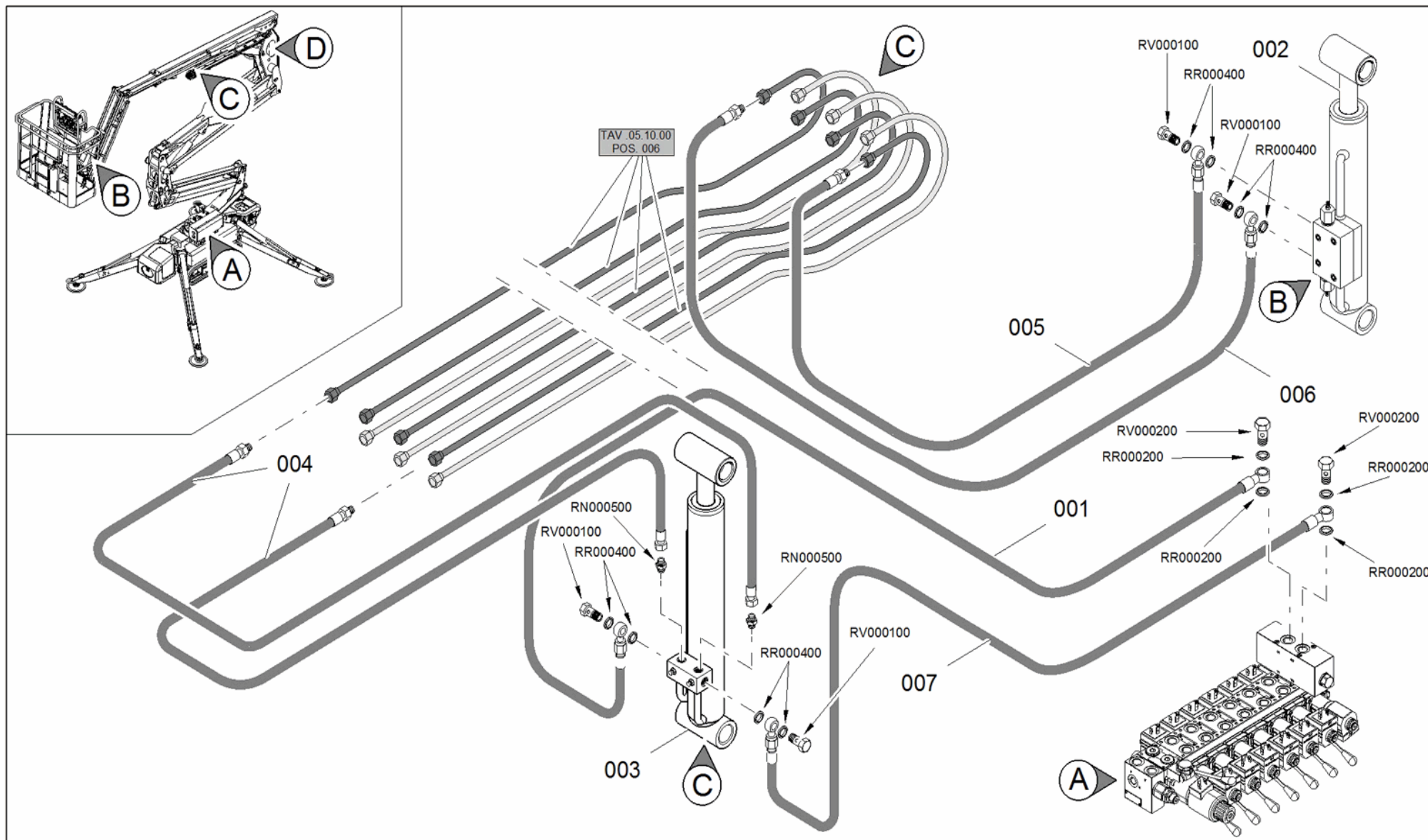





 IMPIANTO IDRAULICO LIVELLAMENTO

HYDRAULIKANLAGE ZYLINDER ARM 

 LEVELING CYLINDERS HYDRAULIC SYSTEM

INSTALACIÓN HIDRÁULICA CILINDROS BRAZOS 

 SYSTÈME HYDRAULIQUE CYLINDRES BRAS

POS Codice	Q.tà	 Descrizione	 Description	 Designation	 Benennung	 Descripción
1 07784900	1 NR	TUBO FLESSIBILE	FLEXIBLE PIPE	TUYAU FLEXIBLE	SCHLAUCH	TUBO FLEXIBLE
2 273151H2	1 NR	CILINDRO LIVELLAMENTO CESTO SU CESTO	LEVELING CYLINDER BASKET ON BASKET	CYLINDRE NIVELLEMENT PANIER SUR PANIER	ZYLINDER KORBNIVELLIERU NG	CILINDRO NIVELACIÓN CESTA
3 270693H2	1 NR	CILINDRO LIVELLAMENTO CESTO	BASKET LEVELLING CYLINDER	CYLINDRE NIVELLEMENT PANIER	ZYLINDER KORBNIVELLIERU NG	CILINDRO NIVELACIÓN CESTA
4 07786000	2 NR	TUBO FLESSIBILE	FLEXIBLE PIPE	TUYAU FLEXIBLE	SCHLAUCH	TUBO FLEXIBLE
5 07786200	1 NR	TUBO FLESSIBILE	FLEXIBLE PIPE	TUYAU FLEXIBLE	SCHLAUCH	TUBO FLEXIBLE
6 07786100	1 NR	TUBO FLESSIBILE	FLEXIBLE PIPE	TUYAU FLEXIBLE	SCHLAUCH	TUBO FLEXIBLE
7 07784800	1 NR	TUBO FLESSIBILE	FLEXIBLE PIPE	TUYAU FLEXIBLE	SCHLAUCH	TUBO FLEXIBLE

 IMPIANTO IDRAULICO ROTAZIONE CESTO

 CAGE ROTATION HYDRAULIC SYSTEM

 SYSTÈME HYDRAULIQUE ROTATION PANIER

HYDRAULIKANLAGE KORBSCHWENKUNG 



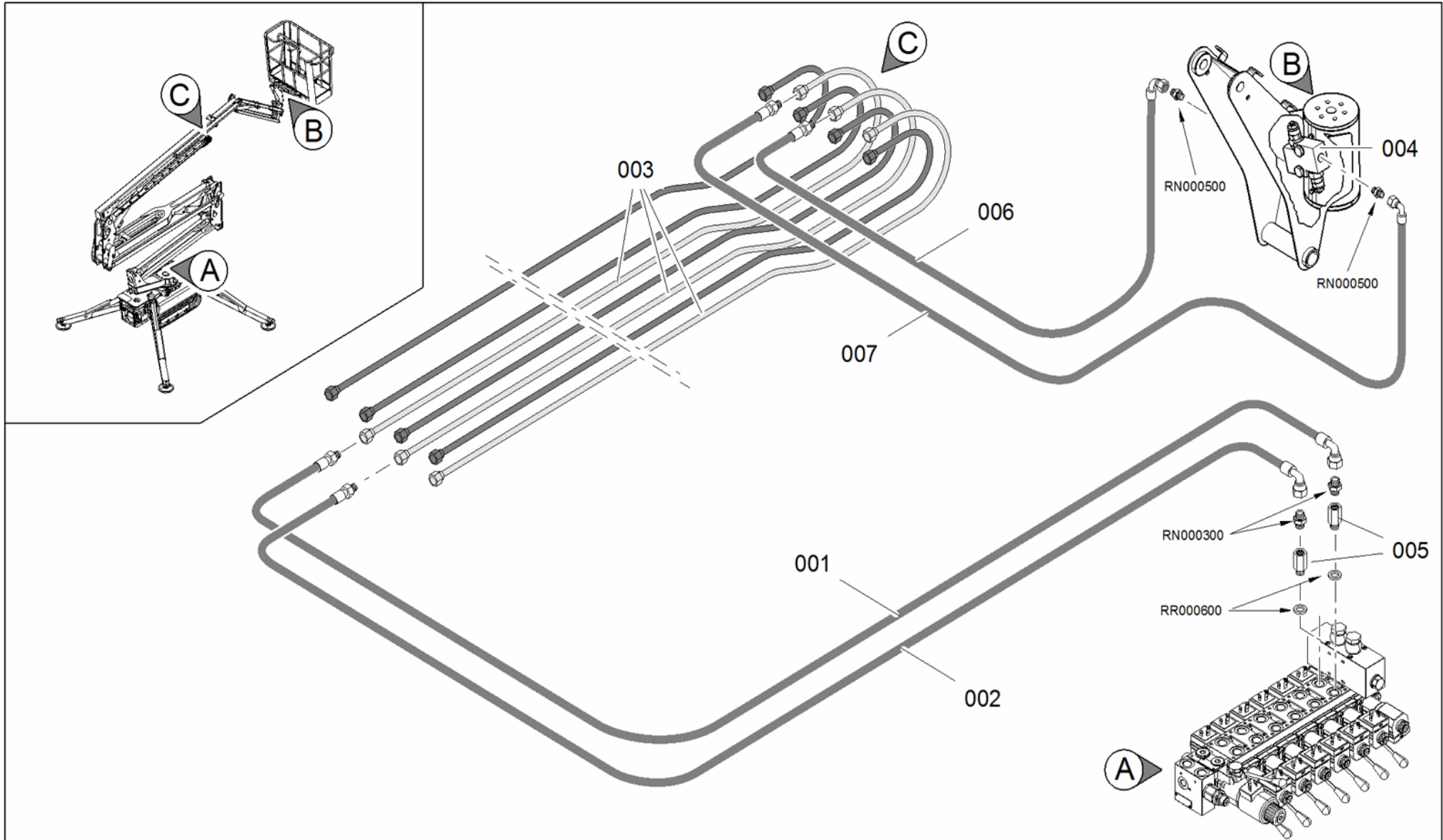

INSTALACIÓN HIDRÁULICA ROTACIÓN CESTA 



 IMPIANTO IDRAULICO ROTAZIONE CESTO

 HYDRAULIKANLAGE KORBSCHWENKUNG 
 CAGE ROTATION HYDRAULIC SYSTEM

 INSTALACIÓN HIDRÁULICA ROTACIÓN CESTA 
 SYSTÈME HYDRAULIQUE ROTATION PANIER

POS Codice	Q.tà	 Descrizione	 Description	 Designation	 Benennung	 Descripción
1 07785800	1 NR	TUBO FLESSIBILE	FLEXIBLE PIPE	TUYAU FLEXIBLE	SCHLAUCH	TUBO FLEXIBLE
2 07785900	1 NR	TUBO FLESSIBILE	FLEXIBLE PIPE	TUYAU FLEXIBLE	SCHLAUCH	TUBO FLEXIBLE
3 07754000	3 NR	TUBO RIGIDO	RIGID PIPE	TUYAU	SCHLAUCH	TUBO
4 2648910001	1 NR	VALVOLA IDRAULICA	HYDRAULIC VALVE	VALVE HYDRAULIQUE	HYDRAULIKVENTI L	VÁLVULA HIDRÁULICA
5 03149500	2 NR	RACCORDO A COLONNA 3/8" H=20	EXTENSION 3/8" H=20	RACCORD	ANSCHLUSS	CONEXIÓN
6 07786500	1 NR	TUBO FLESSIBILE	FLEXIBLE PIPE	TUYAU FLEXIBLE	SCHLAUCH	TUBO FLEXIBLE
7 07786600	1 NR	TUBO FLESSIBILE	FLEXIBLE PIPE	TUYAU FLEXIBLE	SCHLAUCH	TUBO FLEXIBLE

 IMPIANTO IDRAULICO ARIA COMPRESSA



 COMPRESSED AIR HYDRAULIC SYSTEM

 SYSTÈME HYDRAULIQUE AIR COMPRIMÉ



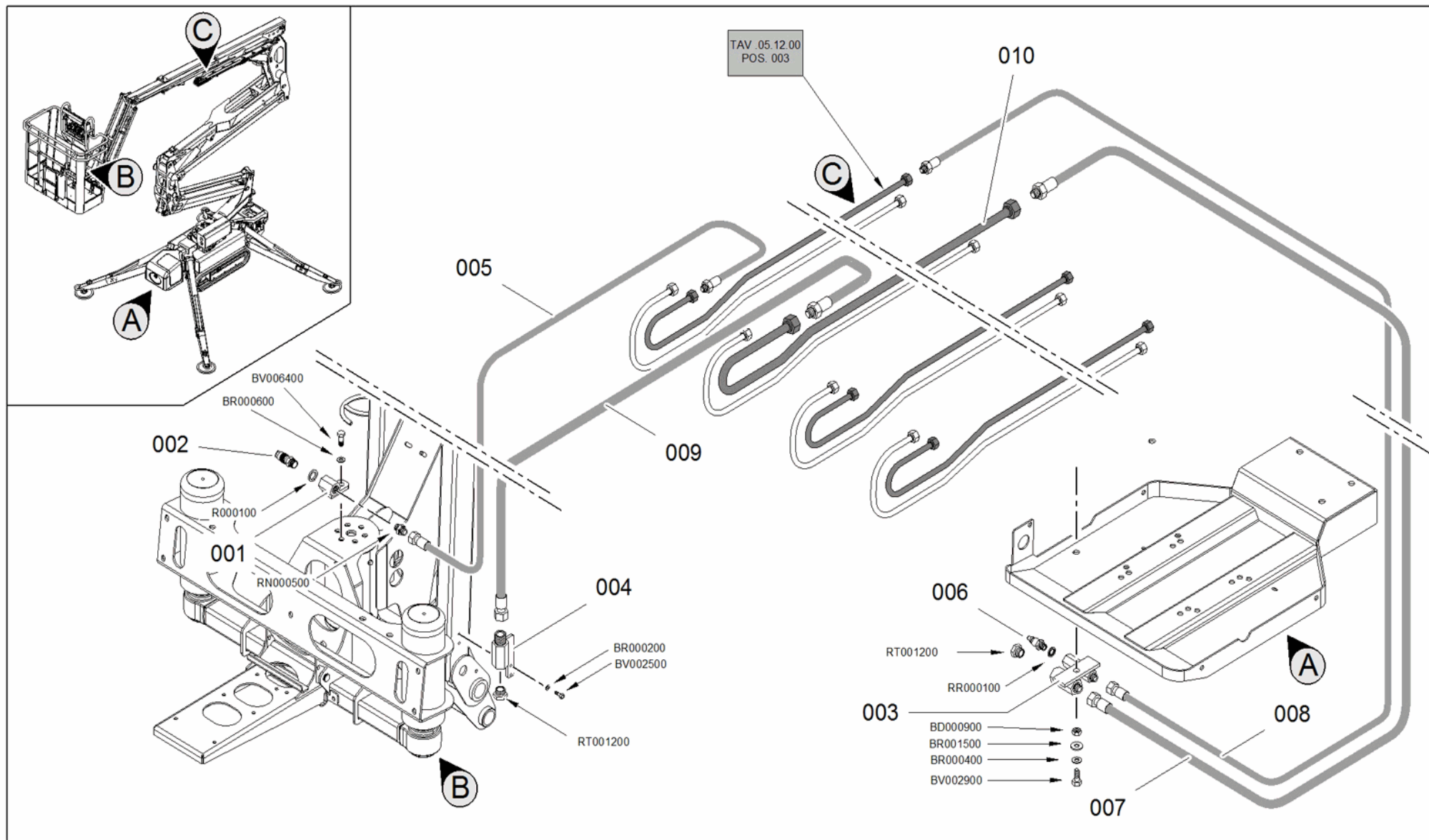

HYDRAULIKANLAGE DRUCKLUFT 

INSTALACIÓN HIDRÁULICA AIRE COMPRIMIDO 



 IMPIANTO IDRAULICO ARIA COMPRESSA
 COMPRESSED AIR HYDRAULIC SYSTEM
 SYSTÈME HYDRAULIQUE AIR COMPRIMÉ

HYDRAULIKANLAGE DRUCKLUFT 
 INSTALACIÓN HIDRÁULICA AIRE COMPRIMIDO 

POS Codice	Q.tà	 Descrizione	 Description	 Designation	 Benennung	 Descripción
1 04845100	1 NR	SUPPORTO	SUPPORT	SUPPORT	HALTERUNG	SOPORTE
2 05509900	1 NR	INNESTO RAPIDO	QUICK COUPLING	RACCORD RAPIDE	SCHNELLKUPPLUNG	CONEXIÓN RÁPIDA
3 07611000	1 NR	RACCORDO	PIPE FITTING	TUYAU	ANSCHLUSS	MANGUITO
4 07611100	1 NR	RACCORDO	HOSE FITTING	TUYAU	ANSCHLUSS	CONEXIÓN
5 07786700	1 NR	TUBO FLESSIBILE	FLEXIBLE PIPE	TUYAU FLEXIBLE	SCHLAUCH	TUBO FLEXIBLE
6 05580200	1 NR	RUBINETTO	FAUCET	ROBINET	WASSERHAHN	GRIFO
7 07785400	1 NR	TUBO FLESSIBILE	FLEXIBLE PIPE	TUYAU FLEXIBLE	SCHLAUCH	TUBO FLEXIBLE
8 07785500	1 NR	TUBO FLESSIBILE	FLEXIBLE PIPE	TUYAU FLEXIBLE	SCHLAUCH	TUBO FLEXIBLE
9 07786800	1 NR	TUBO FLESSIBILE	FLEXIBLE PIPE	TUYAU FLEXIBLE	SCHLAUCH	TUBO FLEXIBLE
10 07754100	1 NR	TUBO RIGIDO	RIGID PIPE	TUYAU	SCHLAUCH	TUBO

 CILINDRI

 CYLINDERS



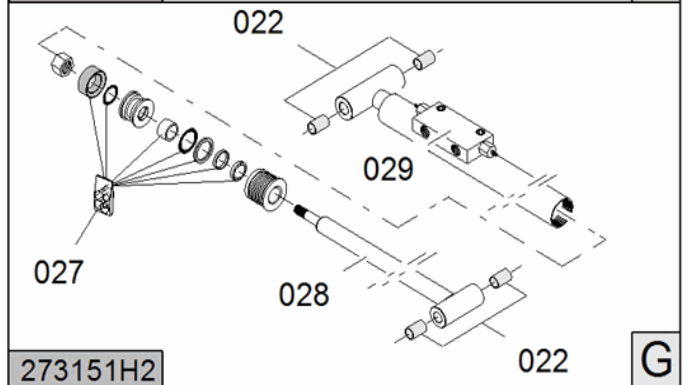
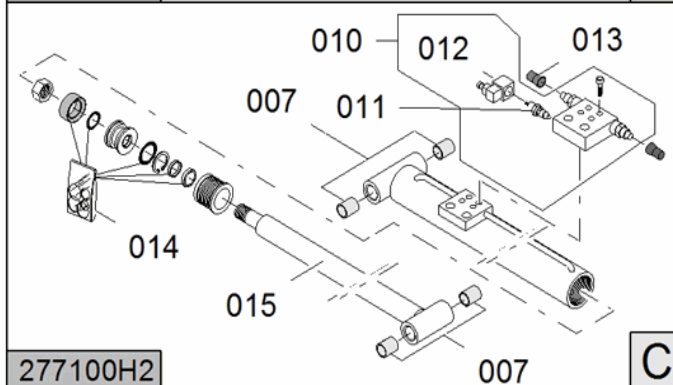
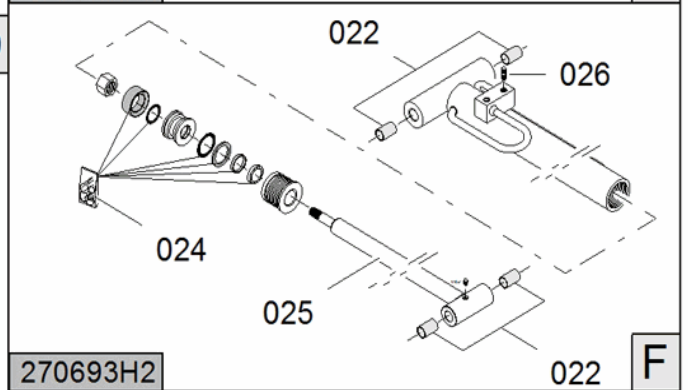
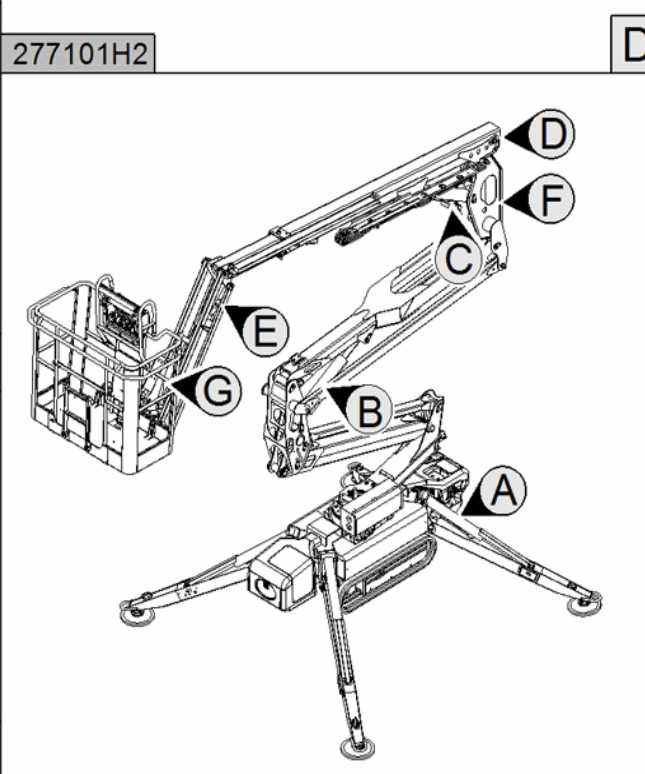
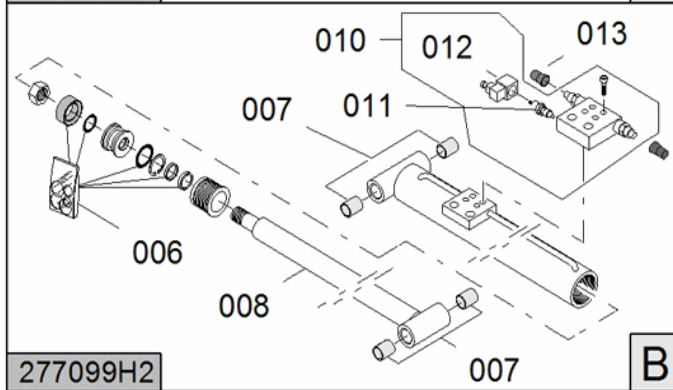
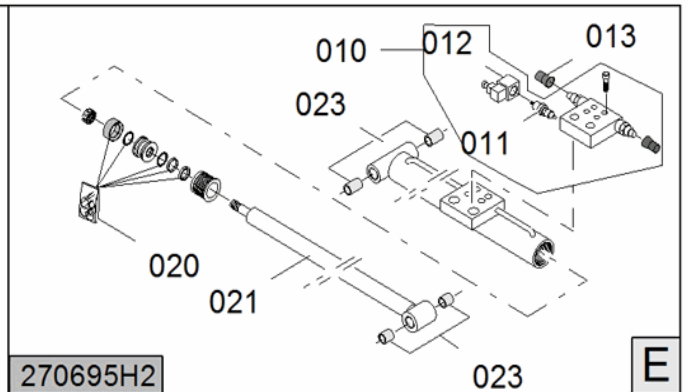
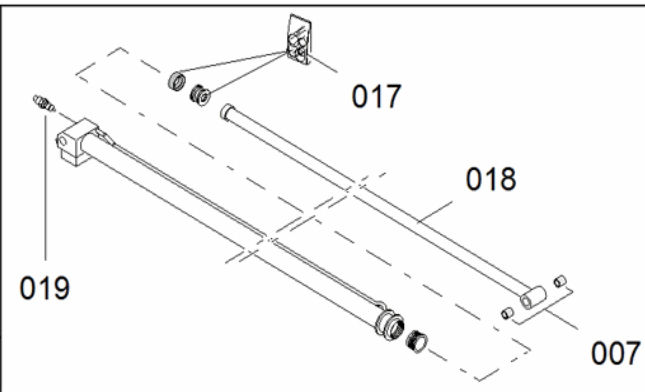
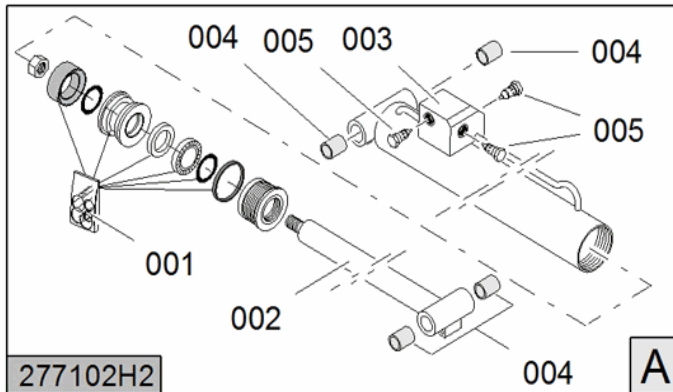

 CYLINDRES

ZYLINDER 





CILINDROS 







 CILINDRIZYLINDER  CYLINDERSCILINDROS  CYLINDRES

POS Codice	Q.tà	 Descrizione	 Description	 Designation	 Benennung	 Descripción
1 2771020003	1 NR	KIT GUARNIZIONI CILINDRO STABILIZZATORE LL1570-X15JP-X4 30AJ	SEAL KIT CYLINDER STABILIZER LL1570-X15JP-X4 30AJ	KIT JOINTS	DICHTUNGSSATZ	KIT JUNTAS
2 2771020001	1 NR	STELO CILINDRO STABILIZZATORE LL1570-X15JP-X4 30AJ	ROD CYLINDER STABILIZER LL1570-X15JP-X4 30AJ	TIGE CYLINDRE	ZYLINDERSCHAF T	VÁSTAGO CILINDRO
3 2705540002	1 NR	BLOCCHETTO	BLOCK	BLOC	BLOCK	BLOQUE
4 07765500	4 NR	BOCCOLA	BUSH	DOUILLE	BUCHSE	CASQUILLO
5 1541150011	3 NR	VALVOLA IDRAULICA	HYDRAULIC VALVE	VALVE HYDRAULIQUE	HYDRAULIKVENTI L	VÁLVULA HIDRÁULICA
6 2770990002	1 NR	KIT GUARNIZIONI CILINDRO BRACCIO 1 LL1570-X15JP-X4 30AJ	SEAL KIT CYLINDER FIRST BOOM LL1570-X15JP-X4 30AJ	KIT JOINTS	DICHTUNGSSATZ	KIT JUNTAS
7 07765200	4 NR	BOCCOLA DEVA.TEX552 303530	BUSH DEVA.TEX 552 303530	DOUILLE	BUCHSE	CASQUILLO
7 07765200	4 NR	BOCCOLA DEVA.TEX552 303530	BUSH DEVA.TEX 552 303530	DOUILLE	BUCHSE	CASQUILLO





 CILINDRIZYLINDER  CYLINDERSCILINDROS  CYLINDRES

POS Codice	Q.tà	 Descrizione	 Description	 Designation	 Benennung	 Descripción
8 2770990001	1 NR	STELO CILINDRO BRACCIO 1 LL1570-X15JP-X4 30AJ	ROD CYLINDER FIRST BOOM LL1570-X15JP-X4 30AJ	TIGE CYLINDER	ZYLINDERSCHAF T	VÁSTAGO CILINDRO
10 26119300	1 NR	VALVOLA IDRAULICA	HYDRAULIC VALVE	VALVE HYDRAULIQUE	HYDRAULIKVENTI L	VÁLVULA HIDRÁULICA
10 26119300	1 NR	VALVOLA IDRAULICA	HYDRAULIC VALVE	VALVE HYDRAULIQUE	HYDRAULIKVENTI L	VÁLVULA HIDRÁULICA
10 26119300	1 NR	VALVOLA IDRAULICA	HYDRAULIC VALVE	VALVE HYDRAULIQUE	HYDRAULIKVENTI L	VÁLVULA HIDRÁULICA
11 0552550001	1 NR	ELETTROVALVOL A	SOLENOID VALVE	ÉLECTROVANNE	MAGNETVENTIL	ELECTROVÁLVU LA
11 0552550001	1 NR	ELETTROVALVOL A	SOLENOID VALVE	ÉLECTROVANNE	MAGNETVENTIL	ELECTROVÁLVU LA
11 0552550001	1 NR	ELETTROVALVOL A	SOLENOID VALVE	ÉLECTROVANNE	MAGNETVENTIL	ELECTROVÁLVU LA
12 0552550003	1 NR	BOBINA	COIL	BOBINE	SPULE	BOBINA
12 0552550003	1 NR	BOBINA	COIL	BOBINE	SPULE	BOBINA
12 0552550003	1 NR	BOBINA	COIL	BOBINE	SPULE	BOBINA
13 05576200	6 NR	PROTEZIONE	PROTECTION	PROTECTION	SCHUTZ	PROTECCIÓN

 CILINDRIZYLINDER  CYLINDERSCILINDROS  CYLINDRES

POS Codice	Q.tà	 Descrizione	 Description	 Designation	 Benennung	 Descripcìon
14 2771000002	1 NR	KIT GUARNIZIONI CILINDRO BRACCIO 3 LL1570-X15JP-X4 30AJ	SEAL KIT CYLINDER THIRD BOOM LL1570-X15JP-X4 30AJ	KIT JOINTS	DICHTUNGSSATZ	KIT JUNTAS
15 2771000001	1 NR	STELO CILINDRO BRACCIO 3 LL1570-X15JP-X4 30AJ	ROD CYLINDER THIRD BOOM LL1570-X15JP-X4 30AJ	TIGE CYLINDRE	ZYLINDERSCHAF T	VÁSTAGO CILINDRO
17 2771010002	1 NR	KIT GUARNIZIONI CILINDRO SFILO LL1570-X15JP-X4 30AJ	SEAL KIT CYLINDER SFILO LL1570-X15JP-X4 30AJ	KIT JOINTS	DICHTUNGSSATZ	KIT JUNTAS
18 2771010001	1 NR	STELO CILINDRO SFILO LL1570-X15JP-X4 30AJ	ROD CYLINDER SFILO LL1570-X15JP-X4 30AJ	TIGE CYLINDRE	ZYLINDERSCHAF T	VÁSTAGO CILINDRO
19 2630690003	1 NR	VALVOLA IDRAULICA	HYDRAULIC VALVE	VALVE HYDRAULIQUE	HYDRAULIKVENTI L	VÁLVULA HIDRÁULICA
20 2706950001	1 NR	KIT GUARNIZIONI CILINDRO JIB	SEAL KIT CYLINDER JIB	KIT DE JOINTS	DICHTUNGSSATZ	KIT JUNTAS CILINDRO JIB
21 2706950002	1 NR	STELO CILINDRO JIB	ROD CYLINDER JIB	TIGE DE CYLINDRE JIB	KORBARM ZYLINDERSCHAF T	VASTAGO CILINDRO JIB

 CILINDRIZYLINDER  CYLINDERSCILINDROS  CYLINDRES

POS Codice	Q.tà	 Descrizione	 Description	 Designation	 Benennung	 Descripción
22 2627890006	4 NR	BOCCOLA	BUSH	DOUILLE	BUCHSE	CASQUILLO
22 2627890006	4 NR	BOCCOLA	BUSH	DOUILLE	BUCHSE	CASQUILLO
23 2627910006	4 NR	BOCCOLA	BUSH	DOUILLE	BUCHSE	CASQUILLO
24 2706930001	1 NR	KIT GUARNIZIONI CILINDRO LIVELLAMENTO SU RINVIO	CYLINDER GASKET KIT	KIT DE JOINTS CYLINDRE NIVELLEMENT	DICHTSATZ ZYLINDER AUSNIVELLIERUN G	KIT DE JUNTAS CILINDRO NIVELACIÓN
25 2706930002	1 NR	STELO CILINDRO LIVELLAMENTO SU RINVIO	ROD CYLINDER	TIGE CYLINDRE	ZYLINDERSCHAF T	VASTAGO CILINDRO
26 2588290008	2 NR	VITE	SCREW	VIS	SCHRAUBE	TORNILLO
27 2706940001	1 NR	KIT GUARNIZIONI CILINDRO LIVELLAMENTO SU CESTO	CYLINDER GASKET KIT	KIT DE JOINTS CYLINDRE NIVELLEMENT	DICHTSATZ	KIT JUNTAS
28 2706940002	1 NR	STELO CILINDRO LIVELLAMENTO SU CESTO	BASKET LEVELING CYLINDER ROD ON BASKET	CYLINDRE TIGE	ZYLINDERSCHAF T	VASTAGO CILINDRO
29 2731510003	1 NR	VALVOLA IDRAULICA	HYDRAULIC VALVE	VALVE HYDRAULIQUE	HYDRAULIKVENTI L	VÁLVULA HIDRÁULICA

 COMPONENTI IMPIANTO ELETTRICO

 ELECTRICAL SYSTEM COMPONENTS

 COMPOSANTS INSTALLATION ÉLECTRIQUE

KOMPONENTEN ELEKTROANLAGE 



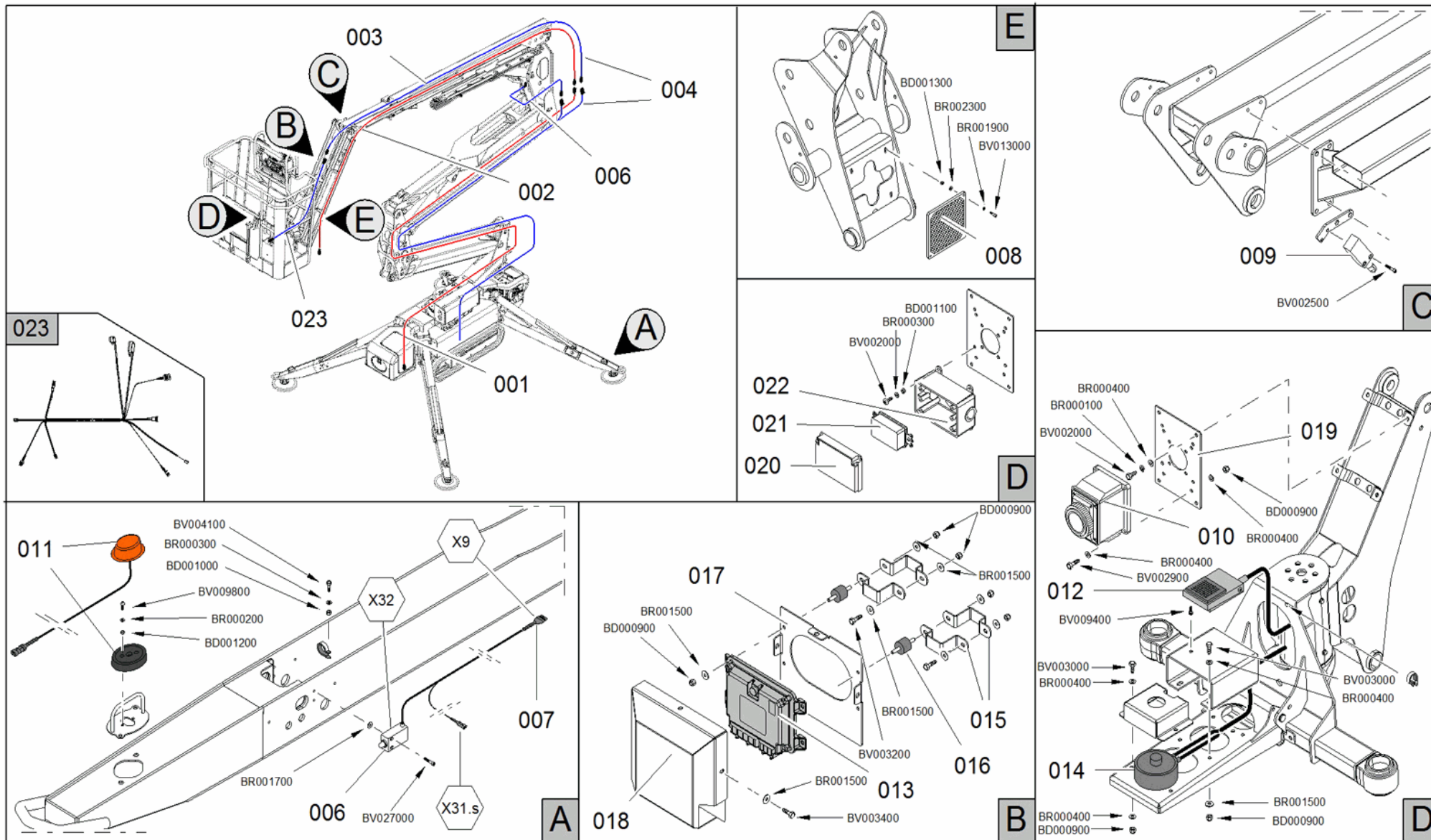

COMPONENTES INSTALACIÓN ELÉCTRICA 



 COMPONENTI IMPIANTO ELETTRICO

 KOMponenten ELEKTROANLAGE 
 ELECTRICAL SYSTEM COMPONENTS

 COMPONENTES INSTALACIÓN ELÉCTRICA 
 COMPOSANTS INSTALLATION ÉLECTRIQUE

POS Codice	Q.tà	 Descrizione	 Description	 Designation	 Benennung	 Descripción
1 1764290002	1 NR	CAVO PROLUNGA 220-110V DA BASE A PRIMO BRACCIO MK2 (DA C170000893)	EXTENSION CABLE 220V-110V FROM BASE TO 1 BOOM MK2 (FROM C170000893)	CÂBLE	KABEL	CABLE
2 1772950013	1 NR	CAVO PROLUNGA 220-110V SFILO LL1570-X15JP-X4 30AJ	EXTENSION CABLE 220V-110V EXTENSION BOOM LL1570-X15JP-X4 30AJ	CÂBLE	KABEL	CABLE
3 1772950014	1 NR	CAVO PROLUNGA 7 POLI SFILO LL1570-X15JP-X4 30AJ	EXTENSION CABLE 7 WIRES EXTENSION BOOM LL1570-X15JP-X4 30AJ	CÂBLE	KABEL	CABLE
4 1730720008	1 NR	CAVO 7 POLI LL1775/200 DA BASE A CESTO	7-POLE CABLE LL1775/200 FROM BASE TO BASKET	CABLE AVEC 7 FILS DE LA BASE JUSQU'A LE PANIER		





 COMPONENTI IMPIANTO ELETTRICO

 KOMponenten ELEKTROANLAGE

 ELECTRICAL SYSTEM COMPONENTS

 COMPONENTES INSTALACIÓN ELÉCTRICA





 COMPOSANTS INSTALLATION ÉLECTRIQUE

POS Codice	Q.tà	 Descrizione	 Description	 Designation	 Benennung	 Descripción
5 1730720094	1 NR	CAVO COMPLETO PER SENSORE DI POSIZIONE 3 CILINDRO BRACCIO	CABLE ASSEMBLY FOR POSITION SENSOR 3 BOOM CYLINDER	CÂBLE COMPLET POUR CAPTEUR DE POSITION 3° CYLINDRE BRAS	KABEL KOMPLETT FÜR POSITIONSENS OR 3. AUSLEGERARM-Z YLINDER	CABLE COMPLETO PARA SENSOR DE POSICIÓN 3ERO CILINDRO BRAZO
6 1772950011	1 NR	MICROINTERRUTT ORE 2 CONTATTI NC/NO TESTINA PULSANTE CAVO LUNGO 2 METRI	MICRO SWITCH CONTACT 2 NC / NO BUTTON HEAD CABLE 2 METER	MICROINTERRUP TEUR	MIKROSCHALTER	MICROINTERRUP TOR
7 1772950012	1 NR	CAVO PROLUNGA STABILIZZATORE LL1570-X15JP-X4 30AJ	EXTENSION CABLE STABILIZER LL1570-X15JP-X4 30AJ	CÂBLE	KABEL	CABLE
8 1679890001	1 NR	CATARIFRANGEN TE 100X100 MM	REFLECTOR 100X100 MM	CATADIOPTRE	REFLEKTOR	CATADIÓPTRICO
9 1679900012	1 NR	MICROINTERRUTT ORE 2 CONTATTI NC/NO TESTINA ROTELLA ACCIAIO CAVO LUNGO 5 METRI	MICRO SWITCH CONTACT 2 NC / NO HEAD STEEL WHEEL LONG CABLE 5 METER	MICROINTERRUP TEUR	MIKROSCHALTER	MICROINTERRUP TOR
10 1585570005	1 NR	PRESA ELETTRICA 230V	ELECTRICAL SOCKET 230V	PRISE ÉLECTRIQUE	STECKDOSE	ENCHUFE ELÉCTRICO

 COMPONENTI IMPIANTO ELETTRICO

 KOMponenten ELEKTROANLAGE 
 ELECTRICAL SYSTEM COMPONENTS





 COMPONENTES INSTALACIÓN ELÉCTRICA 
 COMPOSANTS INSTALLATION ÉLECTRIQUE

POS Codice	Q.tà	 Descrizione	 Description	 Designation	 Benennung	 Descripción
11 1757250023	1 NR	SPIA STABILIZZATORE LED COMPLETA DI CONNETTORE	LED LIGHT	TEMOIN LED	KONTROLLAMP E	INDICADOR LED
13 1772950016	1 NR	SCHEDA ELETTRONICA DI CONTROLLO 48XS PROGRAMMATA PER GESTIONE A RICAMBIO	ELECTRONIC BOARD OF CONTROL 48XS PROGRAMMED FOR SPARE PARTS	CARTE ÉLECTRONIQUE	ELEKTRONISCHE PLATINE	TARJETA ELECTRÓNICA
14 17669800	1 NR	SENSORE CELLA DI CARICO 4-20MA COMPLETO DI CAVO E CONNETTORI M12 (MK2)	SENSOR LOAD CELL 4-20MA WITH CABLE AND CONNECTORS M12 (MK2 VERSION)	CELLULE DE CHARGE (MK2)	MESSDOSE (MK2)	CÉLULA DE CARGA (MK2)
15 077090H2	8 NR	COLLARE FISSAGGIO SCHEDA CELLA DI CARICO TTC	COLLAR FIXING SHEET LOAD CELL TTC	BRIDE	BUNDRING	ABRAZADERA
16 04152300	7 NR	SUPPORTO ELASTICO SUPERIORE RADIATORE -	SPRING SUPPORT	SUPPORT ELASTIQUE	FEDERAUFLAGE	SOPORTE ELASTICO

 COMPONENTI IMPIANTO ELETTRICO

 KOMponenten ELEKTROANLAGE 
 ELECTRICAL SYSTEM COMPONENTS

 COMPONENTES INSTALACIÓN ELÉCTRICA 
 COMPOSANTS INSTALLATION ÉLECTRIQUE

POS Codice	Q.tà	 Descrizione	 Description	 Designation	 Benennung	 Descripció
17 077091H2	1 NR	PIASTRA FISSAGGIO SCHEDA CELLA DI CARICO TTC	FIXING PLATE LOAD CELL CARD TTC	PLAQUE	PLATTE	PLACA
18 077712H2	1 NR	CARTER PROTEZIONE SCHEDA CELLA DI CARICO TTC	CARTER PROTECTION CELL CARD LOAD TTC	CARTER	KURBELGEHÄUS E	CÁRTER
19 077089H2	1 NR	PIASTRA FISSAGGIO PRESE SU CESTO TTC	FIXING PLATE PLUGS ON BASKET TTC	PLAQUE	PLATTE	PLACA
23 17729800	1 NR	KIT IMPIANTO ELETTRICO AL CESTO LL1570-X15JP-X4 30AJ	KIT ELECTRIC PLANT IN BASKET LL1570-X15JP-X4 30AJ	KIT ÉLECTRIQUE	ELEKTROSATZ	KIT ELÉCTRICO

 COMPONENTI IMPIANTO ELETTRICO

 ELECTRICAL SYSTEM COMPONENTS

 COMPOSANTS INSTALLATION ÉLECTRIQUE

KOMPONENTEN ELEKTROANLAGE 



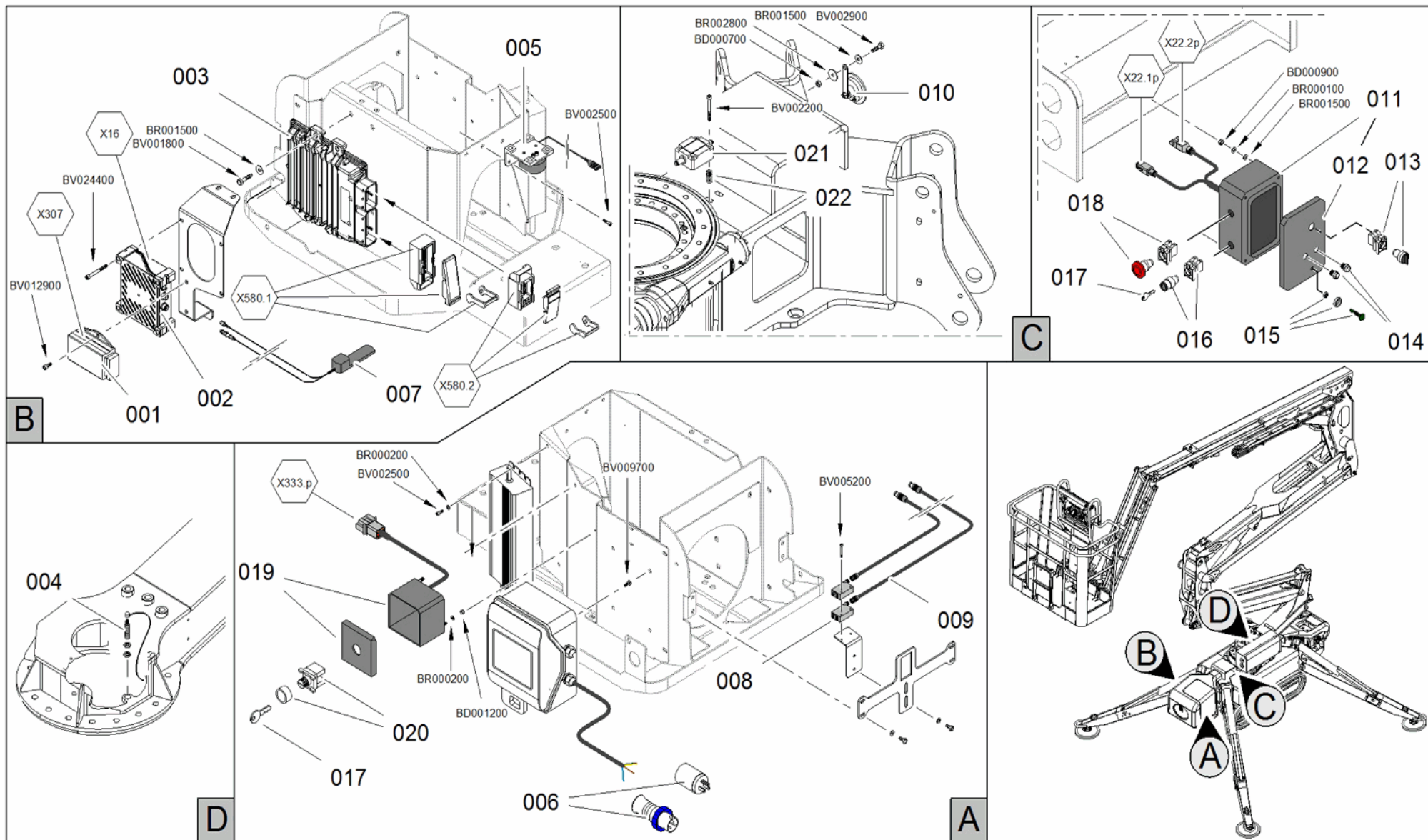

COMPONENTES INSTALACIÓN ELÉCTRICA 



 COMPONENTI IMPIANTO ELETTRICO

 KOMponenten ELEKTROANLAGE 
 ELECTRICAL SYSTEM COMPONENTS





 COMPONENTES INSTALACIÓN ELÉCTRICA 
 COMPOSANTS INSTALLATION ÉLECTRIQUE

POS Codice	Q.tà	 Descrizione	 Description	 Designation	 Benennung	 Descripción
1 1772950021	1 NR	CENTRALINA 4 RELE' INDIPENDENTI 12V A TENUTA	CONTROL UNIT 4 RELAY 'INDEPENDENT 12V SEALED	UNITÉ DE CONTRÔLE	STEUERGERÄT	UNIDAD DE CONTROL
2 1772950017	1 NR	MODEM ESTERNO GPS-4G CAN PROGRAMMATO PER GESTIONE A RICAMBIO	MODEM GPS-4G CAN TO SPARE	MODEM	MODEM	MODEM
3 26582800	1 NR	ADATTATORE PCAN-USB (IPEH-002021)	ADAPTER	ADAPTEUR	ADAPTER	ADAPTADOR
3 1772950018	1 NR	SCHEDA ELETTRONICA DI CONTROLLO 580 PROGRAMMATA PER GESTIONE A RICAMBIO	ELECTRONIC BOARD OF CONTROL 580 PROGRAMMED FOR SPARE PARTS	CARTE ÉLECTRONIQUE	ELEKTRONISCHE PLATINE	TARJETA ELECTRÓNICA
3 07844200	1 NR	RESISTENZA 120 OHM PER CONNETTORE SERIALE RS-232	120 OHM RESISTANCE FOR CONNECTOR RS-232	120 OHM RESISTANCE POUR CONNECTEUR RS-232	120 OHM WIDERSTAND FÜR VERBINDER RS-232	RESISTENCIA 120 OHM PARA CONECTOR RS-232
3 17162400	1 NR	KIT RAMHINO	RAMHINO KIT	KIT RAMHINO	KIT RAMHINO	KIT RAMHINO
3 17162500	1 NR	CAVO RAMHINO	CABLE	CÂBLE	KABEL	CABLE

 COMPONENTI IMPIANTO ELETTRICO

 KOMponenten ELEKTROANLAGE 
 ELECTRICAL SYSTEM COMPONENTS





 COMPONENTES INSTALACIÓN ELÉCTRICA 
 COMPOSANTS INSTALLATION ÉLECTRIQUE

POS Codice	Q.tà	 Descrizione	 Description	 Designation	 Benennung	 Descripción
4 1651290010	1 NR	SENSORE DI PROSSIMITÀ	PROXIMITY SENSOR	CAPTEUR DE PROXIMITÉ	NÄHERUNGSSENSOR	SENSOR DE PROXIMIDAD
6 1757250001	1 NR	SPINA VOLANTE 230V 16A	FREE PLUG 230V 16A	FICHE	STECKER	ENCHUFE
7 27396100	1 NR	ANTENNA	AERIAL	ANTENNE	ANTENNE	ANTENA
8 1591270001	1 NR	FOTOCELLULA	PHOTOCELL	CELLULE PHOTO-ÉLECTRIQUE	PHOTOZELLE	FOTOCÉLULA
9 159127000101	1 NR	CAVO ELETTRICO	ELECTRIC CABLE	CÂBLE ÉLECTRIQUE	ELEKTROKABEL	CABLE ELÉCTRICO
10 04834500	1 NR	CLAXON	HORN	KLAXON	HORN	BOCINA
11 1773980003	1 NR	SCATOLA STOP A TERRA DIESEL LL2614-X26JP-X7 70AJ TT COMPLETA DI CABLAGGIO E CONNETTORE	BOX WITH WIRING	BOÎTE AVEC CÂBLAGE	KASTEN MIT VERKABELUNG	CAJA CON CABLEADO
11 175726002402	1 NR	COPERCHIO SCATOLA STOP A TERRA DIESEL LL2614-X26JP-X7 70AJ	BOX COVER	COUVERCLE BOÎTE	KASTENABDECKUNG	TAPA DE CAJA

 COMPONENTI IMPIANTO ELETTRICO

 KOMponenten ELEKTROANLAGE 
 ELECTRICAL SYSTEM COMPONENTS

 COMPONENTES INSTALACIÓN ELÉCTRICA 
 COMPOSANTS INSTALLATION ÉLECTRIQUE

POS Codice	Q.tà	 Descrizione	 Description	 Designation	 Benennung	 Descripción
12 175726002401	1 NR	COPERCHIO SCATOLA STOP A TERRA DIESEL LL2614-X26JP-X7 70AJ	BOX COVER	COUVERCLE BOÎTE	KASTENABDECK UNG	TAPA DE CAJA
13 1556350068	1 NR	SELETTORE A LEVA 3 POSIZIONI	3 POSITION LEVER SWITCH	SÉLECTEUR	WÄHLSCHALTER	SELECTOR
14 1628400001	1 NR	PULSANTE	BUTTON	BOUTON	DRUCKKNOPF	BOTÓN
15 1730720005	1 NR	SPIA VERDE PARTE AEREA GRANDE	BIG GREEN LIGHT AERIAL PART	VOYANT	KONTROLLLEUC HTE	INDICADOR
16 1692150001	1 NR	BLOCCHETTO	BLOCK	BLOC	BLOCK	BLOQUE
17 1651290015	1 NR	CHIAVE	KEY	CLÉ	SCHLÜSSEL	LLAVE
17 1651290015	1 NR	CHIAVE	KEY	CLÉ	SCHLÜSSEL	LLAVE
18 1773980004	1 NR	PULSANTE	BUTTON	BOUTON	DRUCKKNOPF	BOTÓN
19 1772950019	1 NR	SCATOLA ESCLUSIONE SICUREZZE COMPLETA TTC	BOX EXCLUSION SAFETY TTC	BOÎTE	GEHÄUSE	CAJA
20 1585570006	1 NR	SELETTORE	SELECTOR	SÉLECTEUR	WÄHLSCHALTER	SELECTOR
21 17708000	1 NR	INCLINOMETRO	INCLINOMETER	INCLINOMÈTRE	NEIGUNGSSENS OR	INCLINÓMETRO

 COMPONENTI IMPIANTO ELETTRICOKOMPONENTEN ELEKTROANLAGE  ELECTRICAL SYSTEM COMPONENTSCOMPONENTES INSTALACIÓN ELÉCTRICA  COMPOSANTS INSTALLATION ÉLECTRIQUE

POS Codice	Q.tà	 Descrizione	 Description	 Designation	 Benennung	 Descripcìon
22 05444800	4	NR MOLLA	SPRING	RESSORT	FEDER	MUELLE

 TELECOMANDO

 REMOTE CONTROL



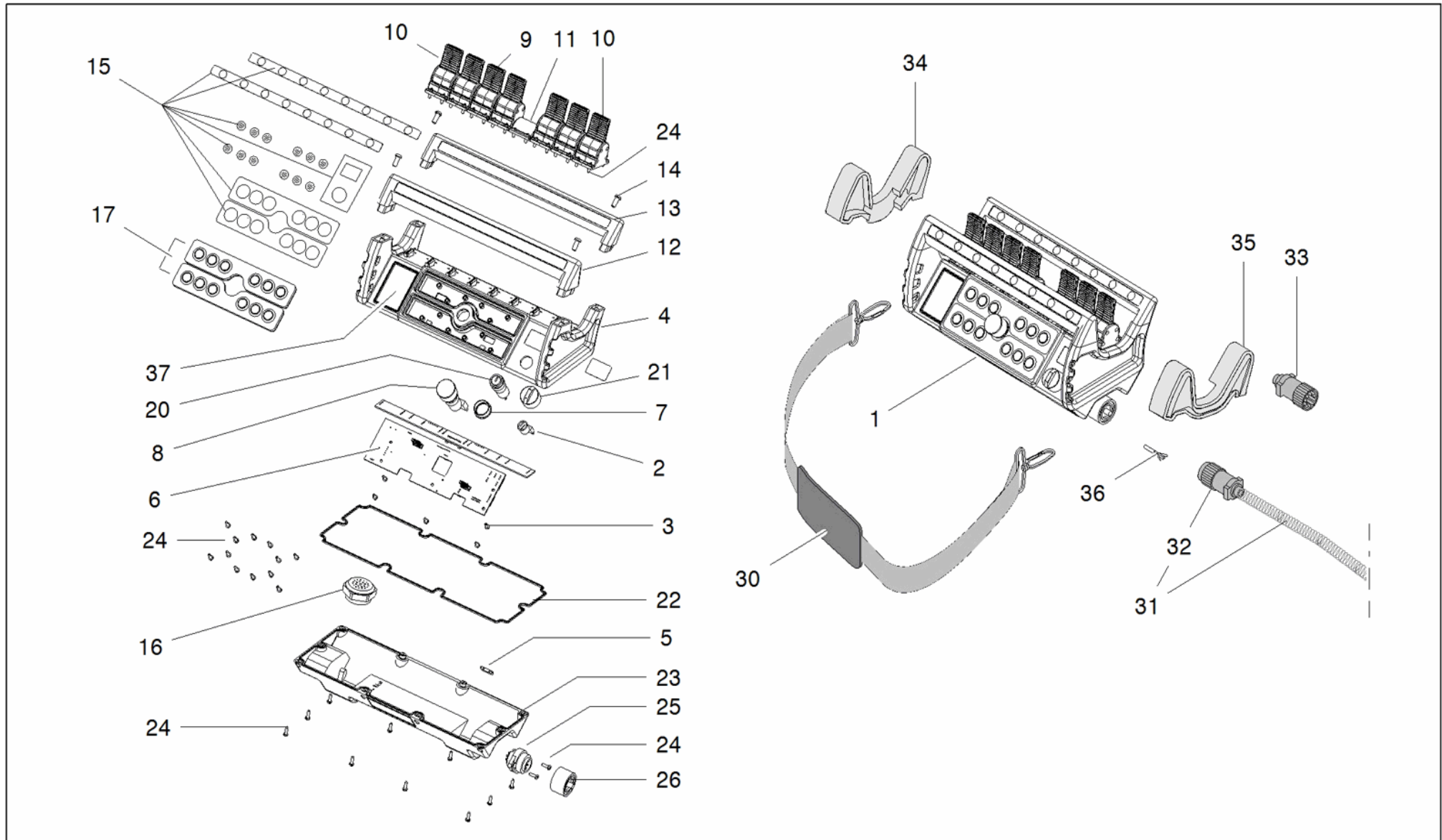

 TÉLÉCOMMANDE

FERNSTEUERUNG 

TELECOMANDO 







 TELECOMANDOFERNSTEUERUNG  REMOTE CONTROLTELECOMANDO  TÉLÉCOMMANDE

POS Codice	Q.tà	 Descrizione	 Description	 Designation	 Benennung	 Descripcìon
1 27237400	1 NR	TELECOMANDO CASE GRIGIO	REMOTE CONTROL GREY CASE	TÉLÉCOMMANDE	FERNSTEUERUN G	TELECOMANDO
2 07359400	1 NR	CONTATTO PER STOP EMERGENZA TELECOMANDO 3S	CONTACT FOR EMERGENCY STOP REMOTE CONTROL 3S	CONTACTE POUR ARRET D'URGENCE	KONTAKT FÜR NOTSTOP	CONTACTO PARA PARADA DE EMERGENCIA
3 2646170003	5 NR	VITI SCHEDA ELETTRONICA	ELECTRONIC BOARD SCREWS	VIS	SCHRAUBEN	TORNILLOS

 TELECOMANDO

 FERNSTEUERUNG 
 REMOTE CONTROL





 TELECOMANDO 
 TÉLÉCOMMANDE

POS Codice	Q.tà	 Descrizione	 Description	 Designation	 Benennung	 Descripcìon
4 2723740001	1 NR	COPERCHIO SUPERIORE TELECOMANDO CASE GRIGIO + DISPLAY E PULSANTI (PER RICAMBIO È NECESSARIO IL SN DEL TELECOMANDO)	TOP COVER REMOTE CONTROL CASE GREY + DISPLAY AND BUTTONS (AS SPARE IS COMPULSORY THE SN OF REMOTE CONTROL)	COUVERCLE	DECKEL	TAPA
4 2723740002	1 NR	COPERCHIO SUPERIORE TELECOMANDO CASE GRIGIO SOLO COPERCHIO, SENZA COMPONENTI E SENZA DISPLAY	TOP COVER REMOTE CONTROL CASE GREY ONLY CASE, WITHOUT COMPONENTS AND DISPLAY	COUVERCLE	DECKEL	TAPA
5 07359500	1 NR	CONTATTO REED INTERNO TELECOMANDO 3S	REED CONTACT INTERNAL REMOTE 3S	REED CONTACT INTÉRIEUR 3S DISTANCE	REEDKONTAKT INDOOR REMOTE 3S	CONTACTO REED 3S REMOTO DE INTERIOR
6 2646170002	1 NR	SCHEDA ELETTRONICA PER TELECOMANDO	ELECTRONIC BOARD FOR REMOTE CONTROL	FICHE ÉLECTRIQUE	ELEKTRONISCHE PLATINE	PLACA ELECTRÓNICA
7 2646170007	1 NR	ANELLO	RING	BAGUE	RING	ANILLO





 TELECOMANDO

 FERNSTEUERUNG 
 REMOTE CONTROL

 TELECOMANDO 
 TÉLÉCOMMANDE

POS Codice	Q.tà	 Descrizione	 Description	 Designation	 Benennung	 Descripción
8 2646170008	1 NR	PULSANTE EMERGENZA	EMERGENCY BUTTON	BOUTON D'URGENCE	NOTSTOP KNOPF	PULSADOR DE EMERGENCIA
9 2646170009	6 NR	LEVA NERA	LEVER BLACK	LEVIER	HEBEL	PALANCA
9 17550700	1 NR	KIT PROTEZIONE IN GOMMA PER JOYSTICK NERA	PROTECTION KIT	PROTECTION KIT	GUMMISCHUTZ KIT	PROTECCIÓN DE GOMA
10 2646170010	2 NR	LEVA ROSSA	LEVER RED	LEVIER	HEBEL	PALANCA
10 17550800	1 NR	KIT PROTEZIONE IN GOMMA PER JOYSTICK ROSSA	PROTECTION	PROTECTION	GUMMISCHUTZ	PROTECCION DE GOMA
12 2646170013	1 NR	IMPUGNATURA INFERIORE	GRIP LOWER PART	POIGNÉE	GRIFF	EMPUÑADURA
13 2646170012	1 NR	IMPUGNATURA SUPERIORE	GRIP UPPER PART	POIGNÉE	GRIFF	EMPUÑADURA
14 2646170014	4 NR	VITE	SCREW	VIS	SCHRAUBE	TORNILLO
15 27005200	1 NR	KIT ADESIVI	DECALS KIT	KIT AUTOCOLLANTS	KLEBERSATZ	KIT PEGATINAS
16 2646170027	1 NR	CICALINO COMPLETO DI SCHEDA ELETTRONICA TELECOMANDO	BEEPER FOR REMOTE CONTROL	BUZZER	SUMMER	ZUMBADOR COMPLETO DE TARJETA ELECTRÓNICA TELEMANDO
17 2646170017	1 NR	PULSANTI	BUTTONS	BOUTONS	DRUCKKNÖPFE	BOTONES





 TELECOMANDOFERNSTEUERUNG  REMOTE CONTROLTELECOMANDO  TÉLÉCOMMANDE

POS Codice	Q.tà	 Descrizione	 Description	 Designation	 Benennung	 Descripcìon
20 2683930001	1 NR	INTERRUTTORE	SWITCH	INTERRUPTEUR	SCHALTER	INTERRUPTOR
21 2683930002	1 NR	CHIAVE ACCENSIONE	IGNITION KEY	CLÉ DE DÉMARRAGE	ZÜNDSCHLÜSSE L	LLAVE DE ENCENDIDO
22 2646170022	1 NR	GUARNIZIONE	GASKET	JOINT	DICHTUNG	GUARNICIÓN
23 2646170023	1 NR	COPERCHIO INFERIORE	COVER LOWER PART	COUVERCLE	DECKEL	TAPA
24 2646170024	56 NR	VITE	SCREW	VIS	SCHRAUBE	TORNILLO
25 2646170025	1 NR	CONNETTORE	CONNECTOR	CONNECTEUR	VERBINGER	CONECTOR
26 2646170026	1 NR	COPERCHIO CONNETTORE	COVER CONNECTOR	COUVERCLE	DECKEL	TAPA
30 2646170030	1 NR	CINGHIA	BELT	COURROIE	RIEMEN	CORREA
31 17235800	1 NR	CAVO TELECOMANDO COMPLETO IIIS /200	COMPLETE REMOTE CONTROL CABLE IIIS /200	CÂBLE COMPLET TÉLÉCOMMANDE IIIS /200	FERNBEDIENUNG SKABEL KOMPLETT IIIS /200	CABLE TELECOMANDO COMPLETO IIIS /200
32 2646170032	1 NR	CONNETTORE COLLEGAMENTO TELECOMANDO	CONNECTOR FOR REMOTE CONTROL	CONNECTEUR	VERBINGER	CONECTOR
33 1684540001	1 NR	DISPOSITIVO DI COMANDO PER ABILITAZIONE EMERGENZA A TERRA	CONTROL DEVICE FOR ACTIVATING THE EMERGENCY GROUND	DISPOSITIF DE COMMANDE EN CAS D'URGENCE	STEUERVORRICHTUNG IM NOTFALL	DISPOSITIVO DE CONTROL DE EMERGENCIA

 TELECOMANDO

 FERNSTEUERUNG 
 REMOTE CONTROL

 TELECOMANDO 
 TÉLÉCOMMANDE

POS Codice	Q.tà	 Descrizione	 Description	 Designation	 Benennung	 Descripción
34 07027200	1 NR	PROTEZIONE SINISTRA	LEFT PROTECTION	PROTECTION GAUCHE	ABDECKUNG LINKS	PROTECCIÓN IZQUIERDA
35 07027100	1 NR	PROTEZIONE DESTRA	RIGHT PROTECTION	PROTECTION DROITS	ABDECKUNG RECHTS	PROTECCIÓN DERECHA
36 27283000	1 NR	PUNTALINO FEMMINA PER CONNETTORE TELECOMANDO	TERMINAL FEMALE CONNECTOR FOR REMOTE CONTROL	CONNECTEUR FEMELLE	VERBINDUNG	CONECTOR
36 2728300001	1 NR	PUNTALINO MASCHIO PER CONNETTORE TELECOMANDO	TERMINAL MALE CONNECTOR FOR REMOTE CONTROL	CONNECTEUR	VERBINDER	CONECTOR
37 07320200	1 NR	SCHERMO LCD (PER RICAMBIO È NECESSARIO IL SN DEL TELECOMANDO)	DISPLAY (AS SPARE IS COMPULSORY THE SN OF REMOTE CONTROL)	ÉCRAN	DISPLAY	PANTALLA

 IMPIANTO ELETTRICO

 ELECTRICAL SYSTEM



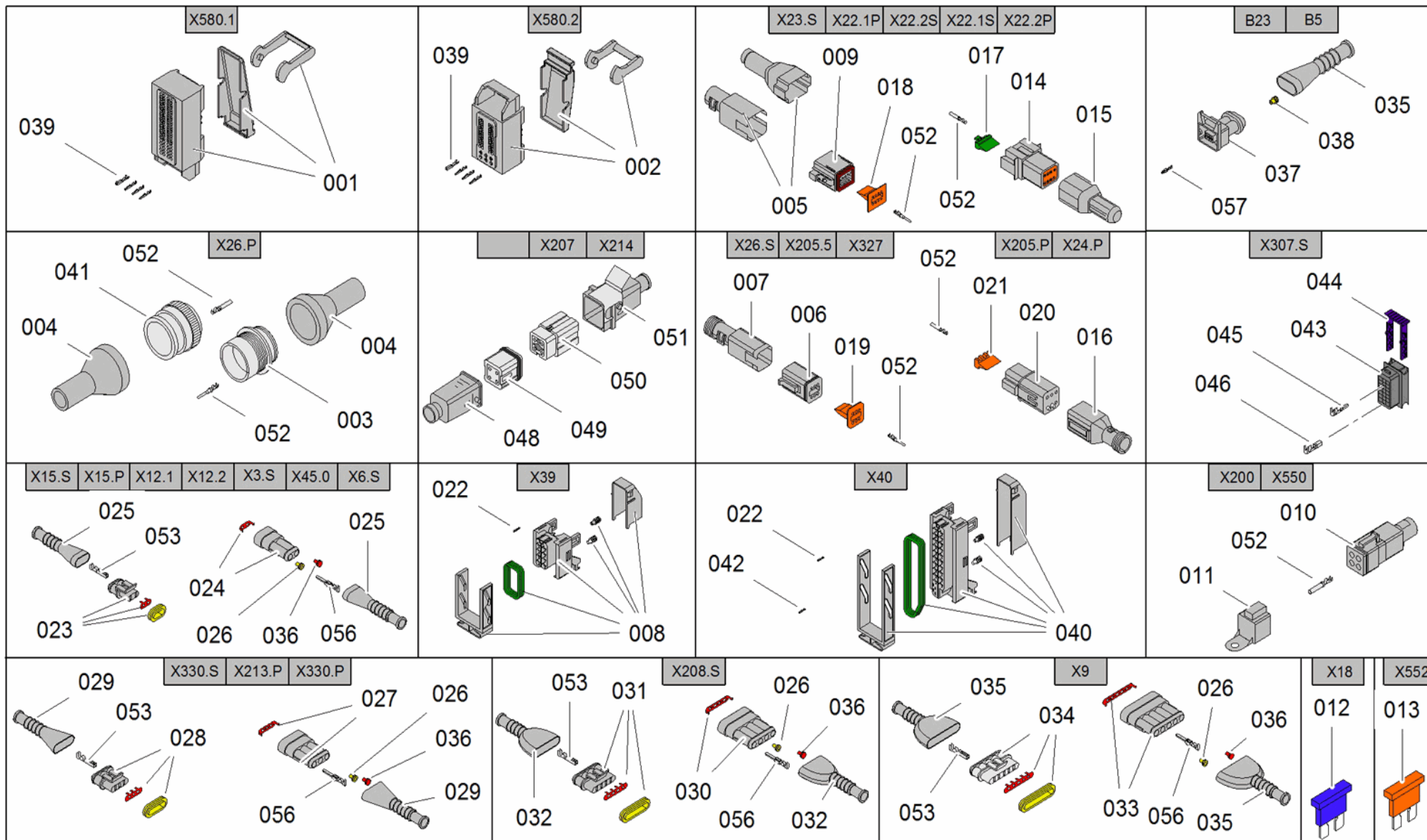

 INSTALLATION ÉLECTRIQUE

ELEKTRISCHE ANLAGE 





INSTALACIÓN ELÉCTRICA 







 IMPIANTO ELETTRICO
ELEKTRISCHE ANLAGE 
 ELECTRICAL SYSTEM
INSTALACIÓN ELÉCTRICA 
 INSTALLATION ÉLECTRIQUE

POS Codice	Q.tà	 Descrizione	 Description	 Designation	 Benennung	 Descripción
1 1772950005	1 NR	CONNETTORE X580.1	CONNECTOR X580.1	CONNECTEUR	VERBINDER	CONECTADOR
2 1772950006	1 NR	CONNETTORE X580.2	CONNECTOR X580.2	CONNECTEUR	VERBINDER	CONECTADOR
3 1730720051	1 NR	CONNETTORE 29 VIE M MOTORE (X26)	CONNECTOR	CONNECTEUR	VERBINDER	CONECTOR
4 1730720054	1 NR	CAPPUCCIO POSTERIORE	CAP	CAPUCHON	KAPPE	CAPUCHO
5 1757250025	1 NR	CAPPUCCIO POSTERIORE PER CONNETTORE MASCHIO	CAP	CAPUCHON	KAPPE	TAPA
5 1730720035	1 NR	COVER POSTERIORE RIGIDA PER CONNETTORE 8 VIE MASCHIO	PROTECTION	PROTECTION	SCHUTZ	PROTECCION
6 1730720037	1 NR	CONNETTORE 6 VIE MASCHIO	6-WAY MALE CONNECTOR	CONNECTEUR 6 VOIES MÂLE	6-WEGE-VERBIN DER	CONECTOR 6 VÍAS
7 1730720039	1 NR	COVER POSTERIORE RIGIDA PER CONNETTORE 6 VIE MASCHIO	PROTECTION	PROTECTION	SCHUTZ	PROTECCION





 IMPIANTO ELETTRICO
ELEKTRISCHE ANLAGE 
 ELECTRICAL SYSTEM
INSTALACIÓN ELÉCTRICA 
 INSTALLATION ÉLECTRIQUE

POS Codice	Q.tà	 Descrizione	 Description	 Designation	 Benennung	 Descripción
8 1772950009	1 NR	CONNETTORE PER 48XS 28 POLI	CONNECTOR FOR 48XS 28P	CONNECTEUR	KLEMMEN	BORNE
9 1730720033	1 NR	CONNETTORE 8 VIE MASCHIO	8-WAY MALE CONNECTOR	CONNECTEUR 8 VOIES MÂLE	8-WEGE-VERBIN DER STIFT	CONECTOR 8 VÍAS MACHO
10 1763330001	1 NR	CONNETTORE 4 VIE MASCHIO DEUTSCH	4-WAY MALE CONNECTOR DEUTSCH	CONNECTEUR 4 VOIES MÂLE DEUTSCH	4-WEGE-VERBIN DER STIFT DEUTSCH	CONECTOR 4 VÍAS MACHO DEUTSCH
11 1763330002	1 NR	CAPPUCCIO FRONTALE CONNETTORE 4 VIE MASCHIO DEUTSCH	CAP FOR 4-WAY MALE CONNECTOR DEUTSCH	PAC CONNECTEUR 4 VOIES MÂLE DEUTSCH	CAP 4-WEGE-VERBIN DER STIFT DEUTSCH	CAP CONECTOR 4 VÍAS MACHO DEUTSCH
12 07700700	1 NR	FUSIBILE A LAMA 25A	FUSE 25A	FUSIBLE 25A	SICHERUNG 25A	FUSIBLE 25A
13 05760700	1 NR	FUSIBILE A LAMA 5A	FUSE 5A	FUSIBLE 5A	SICHERUNG 5A	FUSIBLE 5A
14 1730720029	1 NR	CONNETTORE 8 VIE FEMMINA	8-WAY FEMALE CONNECTOR	CONNECTEUR 8 VOIES FEMELLE	8-WEGE-VERBIN DER BUCHSE	CONECTOR 8 VÍAS HEMBRA





 IMPIANTO ELETTRICOELEKTRISCHE ANLAGE  ELECTRICAL SYSTEMINSTALACIÓN ELÉCTRICA  INSTALLATION ÉLECTRIQUE

POS Codice	Q.tà	 Descrizione	 Description	 Designation	 Benennung	 Descripción
15 1757250026	1 NR	CAPPUCCIO POSTERIORE PER CONNETTORE FEMMINA	CAP	CAPUCHON	KAPPE	TAPA
15 1730720031	1 NR	COVER POSTERIORE RIGIDA PER CONNETTORE 8 VIE FEMMINA	PROTECTION	PROTECTION	SCHUTZ	PROTECCION
16 1757250027	1 NR	CAPPUCCIO POSTERIORE PER CONNETTORE 6 VIE FEMMINA	CAP	CAPUCHON	KAPPE	TAPA
16 1730720084	1 NR	COVER POSTERIORE RIGIDA PER CONNETTORE 6 VIE FEMMINA	PROTECTION	PROTECTION	SCHUTZ	PROTECCION
17 1730720030	1 NR	PIASTRINA DI BLOCCAGGIO CONNETTORE 8 VIE FEMMINA	PLATE	PLAQUE	PLATTE	PLACA





 IMPIANTO ELETTRICO
ELEKTRISCHE ANLAGE 
 ELECTRICAL SYSTEM
INSTALACIÓN ELÉCTRICA 
 INSTALLATION ÉLECTRIQUE

POS Codice	Q.tà	 Descrizione	 Description	 Designation	 Benennung	 Descripción
18 1730720034	1 NR	PIASTRINA DI BLOCCAGGIO CONNETTORE 8 VIE MASCHIO	PLATE	PLAQUE	PLATTE	PLACA
19 1730720038	1 NR	PIASTRINA DI BLOCCAGGIO CONNETTORE 6 VIE MASCHIO	PLATE	PLAQUE	PLATTE	PLACA
20 1730720041	1 NR	CONNETTORE 6 VIE FEMMINA	6-WAY FEMALE CONNECTOR	CONNECTEUR 6 VOIES FEMELLE	6-WEGE-VERBIN DER BUCHSE	CONNECTOR 6 VÍAS HEMBRA
21 1730720042	1 NR	PIASTRA BLOCCAGGIO CONNETTORE 6 VIE FEMMINA	CONNECTOR	CONNECTEUR	VERBINDER	CONNECTADOR
22 1772950007	1 NR	PUNTALINO FEMMINA PER 48XS CAVO 0,5-1	FERRULE FEMALE 48XS 0,5-1	BORNE	KLEMME	BORNE
23 1757250031	1 NR	CONNETTORE SUPERSEAL PF 2 VIE	CONNECTOR	CONNECTEUR	VERBINDER	CONNECTADOR
24 1757250032	1 NR	CONNETTORE SUPERSEAL PM 2 VIE	CONNECTOR	CONNECTEUR	VERBINDER	CONNECTADOR





 IMPIANTO ELETTRICOELEKTRISCHE ANLAGE  ELECTRICAL SYSTEMINSTALACIÓN ELÉCTRICA  INSTALLATION ÉLECTRIQUE

POS Codice	Q.tà	 Descrizione	 Description	 Designation	 Benennung	 Descripción
25 1757250033	1 NR	CAPPUCCIO POSTERIOERE CONNETTORE SUPERSEAL 2 VIE	CAP	CAPUCHON	KAPPE	CAPUCHO
26 1757250043	1 NR	GOMMINO TENUTA PER CAVI CONNETTORI SUPERSEAL	RUBBER SEAL	JOINT EN CAOUTCHOUC	GUMMIDICHTUNG	JUNTA DE GOMA
27 1757250035	1 NR	CONNETTORE SUPERSEAL PM 3 VIE	CONNECTOR	CONNECTEUR	VERBINDER	CONECTADOR
28 1757250034	1 NR	CONNETTORE SUPERSEAL PF 3 VIE	CONNECTOR	CONNECTEUR	VERBINDER	CONECTADOR
29 1757250036	1 NR	CAPPUCCIO POSTERIOERE CONNETTORE SUPERSEAL 3 VIE	CAP	CAPUCHON	KAPPE	CAPUCHO
30 1757250038	1 NR	CONNETTORE SUPERSEAL PM 4 VIE	CONNECTOR	CONNECTEUR	VERBINDER	CONECTADOR
31 1757250037	1 NR	CONNETTORE SUPERSEAL PF 4 VIE	CONNECTOR	CONNECTEUR	VERBINDER	CONECTADOR





 IMPIANTO ELETTRICO
ELEKTRISCHE ANLAGE 
 ELECTRICAL SYSTEM
INSTALACIÓN ELÉCTRICA 
 INSTALLATION ÉLECTRIQUE

POS Codice	Q.tà	 Descrizione	 Description	 Designation	 Benennung	 Descripción
32 1757250039	1 NR	CAPPUCCIO POSTERIORE CONNETTORE SUPERSEAL 4 VIE	CAP	CAPUCHON	KAPPE	CAPUCHO
33 1757250041	1 NR	CONNETTORE SUPERSEAL PM 5 VIE	CONNECTOR	CONNECTEUR	VERBINDER	CONECTADOR
34 1757250040	1 NR	CONNETTORE SUPERSEAL PF 5 VIE	CONNECTOR	CONNECTEUR	VERBINDER	CONECTADOR
34 1757250056	1 NR	CONNETTORE SUPERSEAL PF 6 VIE	CONNECTOR	CONNECTEUR	VERBINDER	CONECTADOR
35 1757250042	1 NR	CAPPUCCIO POSTERIOERE CONNETTORE SUPERSEAL 5-6 VIE	CAP	CAPUCHON	KAPPE	CAPUCHO
36 1757250046	1 NR	GOMMINO TENUTA TAPPO PER CONNETTORI SUPERSEAL	RUBBER SEAL	JOINT EN CAOUTCHOUC	GUMMIDICHTUNG	JUNTA DE GOMA





 IMPIANTO ELETTRICO
ELEKTRISCHE ANLAGE 
 ELECTRICAL SYSTEM
INSTALACIÓN ELÉCTRICA 
 INSTALLATION ÉLECTRIQUE

POS Codice	Q.tà	 Descrizione	 Description	 Designation	 Benennung	 Descripcìon
37 1757250044	1 NR	CONNETTORE JPT 2 VIE PER ELETTRICITÀ	CONNECTOR	CONNECTEUR	VERBINDER	CONECTADOR
38 1757250045	1 NR	GOMMINO TENUTA PER CAVI CONNETTORI JPT	RUBBER SEAL	JOINT EN CAOUTCHOUC	GUMMIDICHTUNG	JUNTA DE GOMA
39 1772950001	1 NR	PUNTALINO FEMMINA PER X580 CAVO SEZ 0,75-1	FERRULE FEMALE X580 0,75-1	BORNE	KLEMMME	BORNE
39 1772950002	1 NR	PUNTALINO FEMMINA PER X580 CAVO SEZ 0,5	FERRULE FEMALE X580 0,5	BORNE	KLEMMME	BORNE
39 1772950003	1 NR	PUNTALINO FEMMINA PER X580 CAVO SEZ 1,5	FERRULE FEMALE X580 1,5	BORNE	KLEMMME	BORNE
39 1772950004	1 NR	PUNTALINO FEMMINA PER X580 CAVO SEZ 2,5	FERRULE FEMALE X580 2,5	BORNE	KLEMMME	BORNE
40 1772950010	1 NR	CONNETTORE PER 48XS 52 POLI	CONNECTOR FOR 48XS 52P	CONNECTEUR	VERBINDER	CONECTADOR





 IMPIANTO ELETTRICO
ELEKTRISCHE ANLAGE 
 ELECTRICAL SYSTEM
INSTALACIÓN ELÉCTRICA 
 INSTALLATION ÉLECTRIQUE

POS Codice	Q.tà	 Descrizione	 Description	 Designation	 Benennung	 Descripción
41 1730720059	1 NR	CONNETTORE 29 VIE F MOTORE (X26)	CONNECTOR	CONNECTEUR	VERBINDER	CONECTADOR
42 1772950008	1 NR	PUNTALINO FEMMINA PER 48XS CAVO 1,5	FERRULE FEMALE 48XS 1,5	BORNE	KLEMMME	BORNE
43 17473600	1 NR	PARTE DI CONNETTORE 24VIE	CONNECTOR PART 24 WAY	CONNECTEUR	VERBINGER	CONECTADOR
44 17473700	1 NR	SLITTA PER CONNETTORE 24 VIE	SLIDE FOR 24-WAY CONNECTOR	COULISSEAU	SCHLITTEN	CORREDERA
45 17306300	1 NR	PUNTALINO FEMMINA PER CONNETTORE 56 VIE SCHEDA MASTER D=1.5	FERRULE FEMALE CONNECTOR 56 WAY MAIN BOARD D = 1.5	BUTÉE FEMELLE CONNECTEUR 56 VOIES CARTE MASTER D = 1.5	AUFLAGESTIFT BUCHSE 56-WEGE-VERBIN DER MASTERPLATINE D = 1.5	CONECTOR PUNTA HEMBRA 56 VÍAS TARJETA MASTER D=1,5
46 17473800	1 NR	PUNTALINO FEMMINA PER CONNETTORE 24 VIE SCHEDA CELLA DI CARICO D=2.8	FERRULE FEMALE CONNECTOR 24 WAY BOARD LOAD CELL D = 2.8	EMBOUT FEMELLE POUR CONNECTEUR 24 VOIES CARTE CELLULE DE CHARGE D=2.8	VERSCHRAUBUN G BUCHSE FÜR 24-WEGE-VERBIN DER KORBLAST-PLATINE D=2,8	PUNTAL HEMBRA PARA CONECTOR 24 VÍAS CELULA DE CARGA D=2.8





 IMPIANTO ELETTRICO
ELEKTRISCHE ANLAGE 
 ELECTRICAL SYSTEM
INSTALACIÓN ELÉCTRICA 
 INSTALLATION ÉLECTRIQUE

POS Codice	Q.tà	 Descrizione	 Description	 Designation	 Benennung	 Descripcìon
47 1730720083	1 NR	CUSTODIA 3 POLI GRIGIA VOLANTE PER CONN.PM 4+1VIE 230/110V (X29)	HOUSING 3 POLE GREY FOR CONN. PM 4 + 1 WAY 230V / 110V (X29)	LOGEMENT	GEHÄUSE	ALOJAMIENTO
48 1730720082	1 NR	FRUTTO CONN.PM 4+1VIE 230/110V (X29)	CONNECTOR PM 4 + 1 WAY 230V / 110V (X 29)	CONNECTEUR	VERBINDER	CONECTADOR
50 1730720080	1 NR	FRUTTO CONN. PF 4+1 VIA 230/110V (X29)	CONNECTOR PF 4 + 1 WAY 230V / 110V (X 29)	CONNECTEUR	VERBINDER	CONECTADOR
51 1730720081	1 NR	CUSTODIA 3 POLI GRIGIA CON GANCIO PER CONN. PF 4+1 VIA 230/110V (X29)	HOUSING 3 POLE GREY WITH HOOK FOR CONN. PF 4 + 1 ROUTE 230 / 110V (X29)	LOGEMENT	GEHÄUSE	ALOJAMIENTO

 IMPIANTO ELETTRICO
ELEKTRISCHE ANLAGE 
 ELECTRICAL SYSTEM
INSTALACIÓN ELÉCTRICA 
 INSTALLATION ÉLECTRIQUE

POS Codice	Q.tà	 Descrizione	 Description	 Designation	 Benennung	 Descripción
52 1730720032	1 NR	TERMINALE MASCHIO CAVO 0.75-1.5	TERMINAL MALE CABLE 0.75-1.5	MALE TERMINAL	TERMINAL MALE	MALE TERMINAL
52 1730720036	1 NR	TERMINALE FEMMINA CONNETTORE M CAVO 0.5-1	TERMINAL FEMALE MALE CONNECTOR CABLE 0.5-1	BORNE FEMELLE	TERMINAL FEMALE	TERMINAL HEMBRA
52 1730720040	1 NR	TERMINALE FEMMINA (X24)	TERMINAL FEMALE (X24)	BORNE FEMELLE (X24)	TERMINAL FEMALE (X24)	TERMINAL HEMBRA (X24)
52 1730720043	1 NR	TERMINALE MASCHIO (X24) DA 0.5 A 0.75	TERMINAL MALE (X24) DA 0.5 A 0.75	BORNE MALE (X24)	TERMINAL MALE (X24)	TERMINAL MACHO (X24)
52 1730720055	1 NR	CONTATTO MASCHIO 25A CAVO 2.5-4	CONTACT MALE 25A CABLE 2.5-4	CONTACT MALE 25A	CONTACT MALE 25A	CONTACT MALE 25A
52 1730720056	1 NR	TAPPO SIZE 12-16 (X26)	CAP SIZE 12-16 (X26)	CAP TAILLE 12-16 (X26)	CAP SIZE 12-16 (X26)	CAP TAMAÑO 12-16 (X26)
52 1730720057	1 NR	TAPPO SIZE 16 (X26)	CAP SIZE 16 (X26)	PLUG SIZE 16 (X26)	PLUG SIZE 16 (X26)	MACHO TALLA 16 (X26)
52 1730720058	1 NR	CONTATTO MASCHIO 7.5A (X26)	CONTACT PIN 7.5A (X26)	CONTACT PIN 7.5A (X26)	CONTACT PIN 7.5A (X26)	CONTACT 7.5A (X26)
52 1730720061	1 NR	CONTATTO FEMMINA 7.5A (X26)	CONTACT FEMALE 7.5A (X26)	CONTACTER 7,5 FEMELLE (X26)	CONTACT FEMALE 7.5A (X26)	CONTACT 7.5A FEMENINO (X26)

 IMPIANTO ELETTRICO
ELEKTRISCHE ANLAGE 
 ELECTRICAL SYSTEM
INSTALACIÓN ELÉCTRICA 
 INSTALLATION ÉLECTRIQUE

POS Codice	Q.tà	 Descrizione	 Description	 Designation	 Benennung	 Descripción
52 1730720068	1 NR	TAPPO SIZE 20 (X1)	CAP SIZE 20 (X1)	PLUG SIZE 20 (X1)	PLUG SIZE 20 (X1)	TAMAÑO DE ENCHUFE 20 (X1)
52 1730720069	1 NR	CONTATTO FEMMINA 25A CONNETTORE M CAVO 2.5-4	CONTACT FEMALE 25A MALE CONNECTOR CABLE 2.5-4	CONTACT FEMELLE 25A	KONTAKT BUCHSE 25A	CONTACT HEMBRA 25A
53 1757250048	1 NR	PUNTALINO FEMMINA PER SUPERSEAL	FERRULE FEMALE FOR SUPERSEAL	FERRULE	NUTMUTTER	ANILLO
56 1757250049	1 NR	PUNTALINO MASCHIO PER SUPERSEAL	FERRULE MALE FOR SUPERSEAL	FERRULE	NUTMUTTER	ANILLO
57 1739150047	1 NR	CONTATTO FEMMINA PER CONNETTORE JPT	CONTACT FEMALE FOR CONNECTOR JPT	CONTACT FEMELLE POUR CONNECTEUR JPT	KONTAKT BUCHSE FÜR JPT VERBINDER	CONTACTO HEMBRA PARA CONECTOR JPT

 IMPIANTO ELETTRICO

 ELECTRICAL SYSTEM



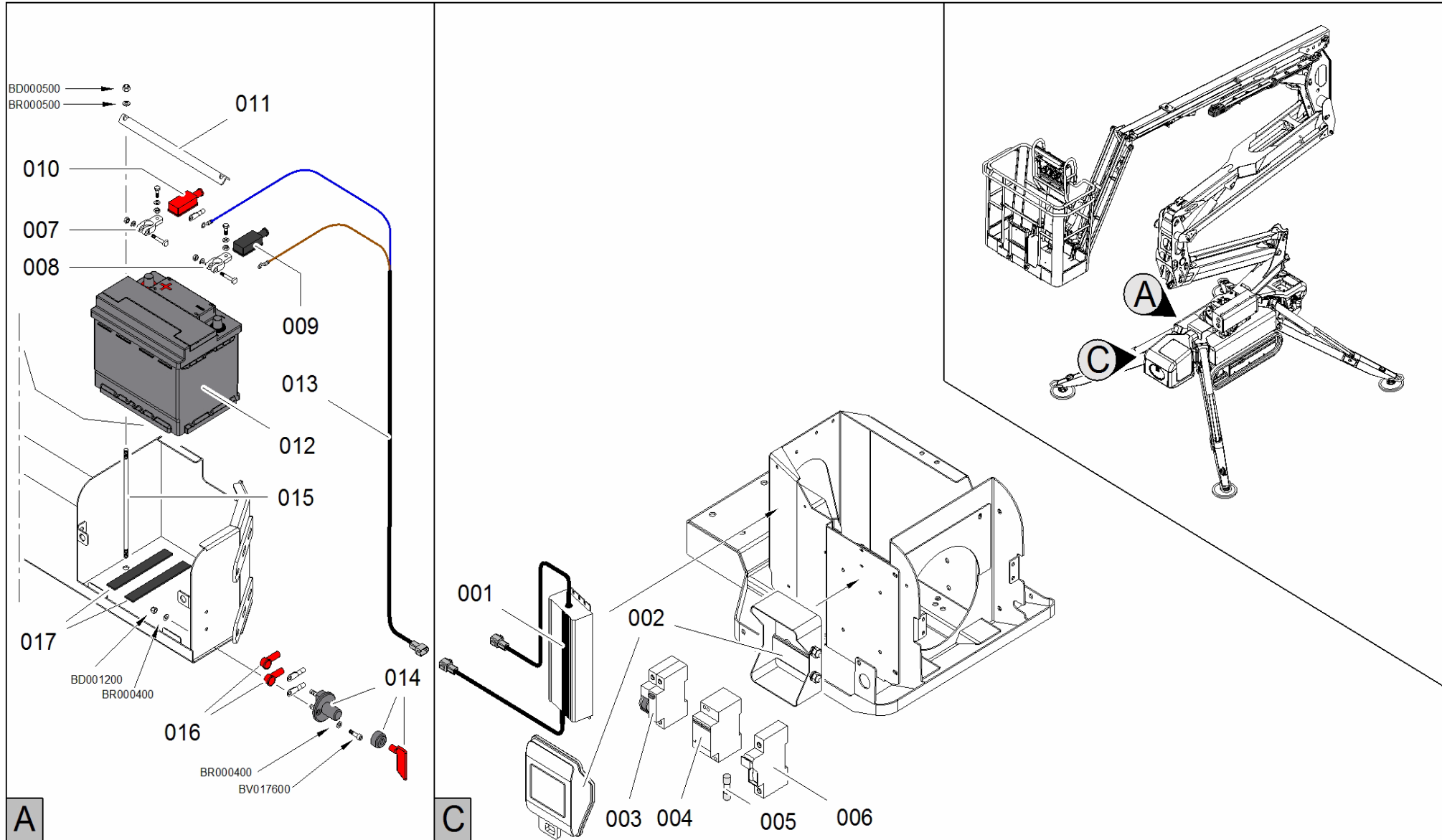

 INSTALLATION ÉLECTRIQUE

ELEKTRISCHE ANLAGE 





INSTALACIÓN ELÉCTRICA 







 IMPIANTO ELETTRICO
ELEKTRISCHE ANLAGE 
 ELECTRICAL SYSTEM
INSTALACIÓN ELÉCTRICA 
 INSTALLATION ÉLECTRIQUE

POS Codice	Q.tà	 Descrizione	 Description	 Designation	 Benennung	 Descripcìon
1 1757250007	1 NR	ALIMENTATORE ELETTRONICO 285W REGOLABILE IP65 PER BATTERIE 55-75 AH COMPLETO DI CONNETTORI	ELECTRONIC BALLAST	ALIMENTATEUR ÉLECTRONIQUE	ELEKTRONISCHE S NETZGERÄT	ALIMENTADOR ELETRÓNICO
2 1757250008	1 NR	SCATOLA ELETTRICO PLASTICA 6 MODULI BI COPERCHIO TRASPARENTE	ELECTRICAL BOX	BOÎTE ÉLECTRIQUE	SCHALTKASTEN	CAJA ELÉCTRICA
3 1556350063	1 NR	INTERUTTORE AUTOMATICO MAGNETOTERMI CO 110-120V 25A (FINO A C170000355 MONTATO C16 SU MACCHINE 120V)	AUTOMATIC THERMAL SWITCH 110-120V 25A (UNTIL C170000355 MOUNTED C16 ON 120V MACHINES)	INTERRUPTEUR	SCHALTER	INTERRUPTOR
4 1757250006	1 NR	TELERUTTORE 4POLI 63A CA/CC	RELAY	RELAIS	RELAIS	RELÉ
5 1730720017	1 NR	FUSIBILE A TUBO 10A	TUBE FUSE 10A	FUSIBLE	SICHERUNG	FUSIBLE

 IMPIANTO ELETTRICO
ELEKTRISCHE ANLAGE 
 ELECTRICAL SYSTEM
INSTALACIÓN ELÉCTRICA 
 INSTALLATION ÉLECTRIQUE

POS Codice	Q.tà	 Descrizione	 Description	 Designation	 Benennung	 Descripción
6 1730720015	1 NR	PORTAFUSIBILE A TUBO 220/110V	FUSE HOLDER TUBE 220/110V	BOÎTE À FUSIBLES	SICHERUNGSKA STEN	PORTAFUSIBLES
7 1739150023	1 NR	MORSETTO POSITIVO A C PER BATTERIA M10	POSITIVE BATTERY CLAMP "C" M10	BORNE POSITIVE A C POUR BATTERIE M10	POSITIVE KLEMME FÜR BATTERIE M10	BORNE POSITIVO A C PARA BATERÍA M10
8 1739150025	1 NR	MORSETTO NEGATIVO A C PER BATTERIA M10	NEGATIVE BATTERY TERMINAL C M10	BORNE NEGATIVE A C POUR BATTERIE M10	NEGATIVE KLEMME FÜR BATTERIE M10	BORNE NEGATIVO A C PARA BATERÍA M10
9 2632920008	1 NR	COPRI POLI BATTERIA QUADRATO NERO	POLE BATTERY COVER BLACK SQUARE	POLE BATTERIE COUVERTURE CARRÉ NOIR	POLE BATTERY COVER BLACK SQUARE	TAPAS BATERIA
10 2632920007	1 NR	COPRI POLI BATTERIA QUADRATO ROSSO	POLE BATTERY COVER RED SQUARE	POLE CACHE BATTERIE RED SQUARE	POLE BATTERY COVER RED SQUARE	TAPAS DE LA BATERIA
11 077483Y1	1 NR	PIEGATO FISSAGGIO BATTERIA LL1570	BENT FIXING BATTERY LL1570	SUPPORT	HALTERUNG	SOPORTE
12 27668600	1 NR	BATTERIA AGM S&S 12V 60AH 680A L02	BATTERY AGM S&S 12V 60AH 680A L02	BATTERIE AGM S&S 12V 60AH 680A L02	BATTERIE AGM S&S 12V 60AH 680A L02	BATERÍA AGM S&S 12V 60AH 680A L02

 IMPIANTO ELETTRICO
ELEKTRISCHE ANLAGE 
 ELECTRICAL SYSTEM
INSTALACIÓN ELÉCTRICA 
 INSTALLATION ÉLECTRIQUE

POS Codice	Q.tà	 Descrizione	 Description	 Designation	 Benennung	 Descripción
13 1772950020	1 NR	LINEA DA ALIMENTATORE A BATTERIA COMPLETA DI CONNETTORI E DIODO LL1570-X15JP-X4 30AJ	LINE FROM CHARGER TO BATTERY WITH CONNECTORS AND DIODE LL1570-X15JP-X4 30AJ	LIGNE	LEITUNG	LÍNEA
13 17572600081	1 NR	CONNETTORE DEUTSCH 2 VIE COMPLETO DI DIODO CON PROTEZIONE	DEUTSCH CONNECTOR 2 WAYS OF COMPLETE WITH PROTECTION DIODE	CONNECTEUR	VERBINDER	CONECTOR
14 04774900	1 NR	STACCA BATTERIA	BATTERY CUT-OFF DEVICE	COUPE BATTERIE	BATTERIETRENN SCHALTER	CORTA-BATERÍA
15 06551000	2 NR	TIRANTE	TIE ROD	TIRANT	TURMGESTÄNGE	TIRANTE
16 1733730029	1 NR	COPRIPOLO BATTERIA ROSSO GRANDE	BIG RED COVER FOR BATTERY POLE	PROTECTION PÔLE ROUGE GRAND	ROTE POLKAPPE BATTERIE	CUBREPOLO BATERÍA ROJO GRANDE
17 07894800	2 NR	GOMMA ADESIVA DI PROTEZIONE L=190	RUBBER ADHESIVE PROTECTION L=190	GOMME ADHESIVE DE PROTECTION L=190	SCHUTZ-KLEBEG UMMI L=190	GOMA ADHESIVA DE PROTECCIÓN L=190



 ADESIVI



 STICKER

 AUTOCOLLANT



AUFKLEBER 



PEGATINA 





 ADESIVI
 STICKER
 AUTOCOLLANT



AUFKLEBER 
PEGATINA 



POS Codice	Q.tà	 Descrizione	 Description	 Designation	 Benennung	 Descripció
------------	------	---	---	---	---	--





 ADESIVI
 STICKER
 AUTOCOLLANT



AUFKLEBER 
 PEGATINA 



POS Codice	Q.tà	 Descrizione	 Description	 Designation	 Benennung	 Descripcìon
0 1778800001	2 NR	ADESIVO	DECAL	AUTOCOLLANT	AUFKLEBER	PEGATINA
0 1778800002	2 NR	ADESIVO	DECAL	AUTOCOLLANT	AUFKLEBER	PEGATINA
0 06039600	8 NR	ADESIVO	STICKER	AUTOCOLLANT	AUFKLEBER	PEGATINA
0 06039700	1 NR	ADESIVO	STICKER	AUTOCOLLANT	AUFKLEBER	PEGATINA
0 06040100	8 NR	ADESIVO	STICKER	AUTOCOLLANT	AUFKLEBER	PEGATINA
0 06040300	4 NR	ADESIVO	STICKER	AUTOCOLLANT	AUFKLEBER	PEGATINA
0 06040400	1 NR	ADESIVO USARE GUANTI SCARPE CUFFIE L=83 X 160 MM (**)	DECAL	AUTOCOLLANT	AUFKLEBER	PEGATINA
0 06040500	2 NR	ADESIVO	STICKER	AUTOCOLLANT	AUFKLEBER	PEGATINA
0 06040900	4 NR	ADESIVO	STICKER	AUTOCOLLANT	AUFKLEBER	PEGATINA
0 06041200	4 NR	ADESIVO	STICKER	AUTOCOLLANT	AUFKLEBER	PEGATINA
0 06041300	13 NR	ADESIVO	STICKER	AUTOCOLLANT	AUFKLEBER	PEGATINA
0 06041600	1 NR	ADESIVO CARBURANTE BENZINA COLORE VERDE L=60 X 80 (**)	DECAL	AUTOCOLLANT	AUFKLEBER	PEGATINA
0 06056300	1 NR	ADESIVO	STICKER	AUTOCOLLANT	AUFKLEBER	PEGATINA





 ADESIVI
 STICKER
 AUTOCOLLANT



AUFKLEBER 
PEGATINA 



POS Codice	Q.tà	 Descrizione	 Description	 Designation	 Benennung	 Descripción
0 06060000	1 NR	ADESIVO	STICKER	AUTOCOLLANT	AUFKLEBER	PEGATINA
0 06085900	1 NR	ADESIVO	STICKER	AUTOCOLLANT	AUFKLEBER	PEGATINA
0 06086000	1 NR	ADESIVO	STICKER	AUTOCOLLANT	AUFKLEBER	PEGATINA
0 06086200	4 NR	ADESIVO ANELLO ATTACCO ANCORAGGIO Ø 50 COLORE BLU	DECAL ANCHOR RING SHANK Ø 50 BLUE	AUTOCOLLANT ANNEAU FIXATION ANCRAGE Ø 50 COULEUR BLEU	KLEBESCHILD ANSCHLUSSRING VERANKERUNG Ø 50 FARBE BLAU	PEGATINA ANILLO ENGANCHE ANCLAJE Ø 50 COLOR AZUL
0 06086700	6 NR	ADESIVO	STICKER	AUTOCOLLANT	AUFKLEBER	PEGATINA
0 06136900	1 NR	ADESIVO PUNTI INGRASSAGGIO Ø 55 TESTO NERO - SFONDO BIANCO (**)	STICKER GREASE POINTS Ø 55	AUTOCOLLANT POINTS GRAISSANGE Ø 55 TEXTE NOIR - FOND BLANC (**)	AUFKLEBER SCHMIERPUNKTE Ø 55, SCHWARZER TEXT - WEIßER UNTERGRUND	PEGATINS PUNTOS ENGRASE Ø 55 TEXTO NEGRO - FONDO BLANCO (**)
0 06164600	1 NR	ADESIVO	STICKER	AUTOCOLLANT	AUFKLEBER	PEGATINA
0 06164700	1 NR	ADESIVO	STICKER	AUTOCOLLANT	AUFKLEBER	PEGATINA
0 06165000	1 NR	ADESIVO	STICKER	AUTOCOLLANT	AUFKLEBER	PEGATINA
0 06207700	1 NR	ADESIVO	STICKER	AUTOCOLLANT	AUFKLEBER	PEGATINA





 ADESIVI
 STICKER
 AUTOCOLLANT



AUFKLEBER 
 PEGATINA 



POS Codice	Q.tà	 Descrizione	 Description	 Designation	 Benennung	 Descripcìon
0 06226900	1 NR	ADESIVO "OLIO IDRAULICO " 7 LINGUE SFONDO BIANCO L=60X60 MM (**)	DECAL	AUTOCOLLANT	AUFKLEBER	PEGATINA
0 06227200	1 NR	ADESIVO "CONTROLLARE LIVELLO OLIO MOTORE " 7 LINGUE GIALLO L=82X108 (**)	DECAL	AUTOCOLLANT	AUFKLEBER	PEGATINA
0 06232100	1 NR	ADESIVO	STICKER	AUTOCOLLANT	AUFKLEBER	PEGATINA
0 06254800	1 NR	ADESIVO" STOP EMERGENZA" SFONDO GIALLO L=100X50 (**)	DECAL	AUTOCOLLANT	AUFKLEBER	PEGATINA
0 06311200	4 NR	ADESIVO VIETATO SOLLEVARE DA QUESTO PUNTO Ø 40 (**)	DECAL	AUTOCOLLANT	AUFKLEBER	PEGATINA
0 06396200	4 NR	ADESIVO "NON FISSARE NESSUNA CORDA SUI TIRANTI" 7 LINGUE L=35X145	DECAL	AUTOCOLLANT	AUFKLEBER	PEGATINA





 ADESIVI
 STICKER
 AUTOCOLLANT



AUFKLEBER 
 PEGATINA 



POS Codice	Q.tà	 Descrizione	 Description	 Designation	 Benennung	 Descripció
0 06448100	2 NR	ADESIVO	STICKER	AUTOCOLLANT	AUFKLEBER	PEGATINA
0 06448200	2 NR	ADESIVO	STICKER	AUTOCOLLANT	AUFKLEBER	PEGATINA
0 06555500	1 NR	ADESIVO	STICKER	AUTOCOLLANT	AUFKLEBER	PEGATINA
0 06555600	1 NR	ADESIVO	STICKER	AUTOCOLLANT	AUFKLEBER	PEGATINA
0 07240300	1 NR	ADESIVO	STICKER	AUTOCOLLANT	AUFKLEBER	PEGATINA
0 07268300	8 NR	ADESIVO	DECAL	AUTOCOLLANT	AUFKLEBER	PEGATINA
0 07268400	4 NR	ADESIVO	DECAL	AUTOCOLLANT	AUFKLEBER	PEGATINA
0 07499300	1 NR	ADESIVO DON'T OPEN THE CASE SFONDO GIALLO L=60X17 MM	DECAL	AUTOCOLLANT	AUFKLEBER	PEGATINA
0 07668100	1 NR	ADESIVO PULSANTI DISTRIBUTORE PARTE AEREA LL2614 L=318X52 MM	DECAL	AUTOCOLLANT	AUFKLEBER	PEGATINA
0 07668200	1 NR	ADESIVO EMERGENCY STOP E BLOCCHETTO ACCENSIONE L=85X160 MM	DECAL	AUTOCOLLANT	AUFKLEBER	PEGATINA





 ADESIVI
 STICKER
 AUTOCOLLANT

AUFKLEBER 
 PEGATINA 

POS Codice	Q.tà	 Descrizione	 Description	 Designation	 Benennung	 Descripció
0 07668300	1 NR	ADESIVO	DECAL	AUTOCOLLANT	AUFKLEBER	PEGATINA
0 07725600	1 NR	ADESIVO	DECAL	AUTOCOLLANT	AUFKLEBER	PEGATINA
0 07725800	1 NR	ADESIVO	DECAL	AUTOCOLLANT	AUFKLEBER	PEGATINA
0 07787700	1 NR	ADESIVO	DECAL	AUTOCOLLANT	AUFKLEBER	PEGATINA
0 07799100	1 NR	ADESIVO	DECAL	AUTOCOLLANT	AUFKLEBER	PEGATINA
0 07799200	4 NR	ADESIVO	DECAL	AUTOCOLLANT	AUFKLEBER	PEGATINA
0 07802200	2 NR	ADESIVO RUMORE 102 DB L=90X100 MM	STICKER NOISE 102 DB L = 90 X 100 MM	AUTOCOLLANT	AUFKLEBER	PEGATINA
0 07839500	4 NR	ADESIVO	DECAL	AUTOCOLLANT	AUFKLEBER	PEGATINA
0 07878400	1 NR	ADESIVO CASCO IMBRAGATURA E DIVIETI LL1370 L=175X118 MM	STICKER HELMET HARNESS AND BANS	AUTOCOLLANT CASQUE HARNAIS ET INTERDICTION	STICKER HELMGURT UND VERBOTE	ETIQUETA ARNÉS CASCO Y PROHIBICIONES
0 1001125483	5 NR	ADESIVO	STICKER	AUTOCOLLANT	AUFKLEBER	PEGATINA
0 1608710001	1 NR	ADESIVO	STICKER	AUTOCOLLANT	AUFKLEBER	PEGATINA
0 1608710002	1 NR	ADESIVO	STICKER	AUTOCOLLANT	AUFKLEBER	PEGATINA
0 1702155	1 NR	ADESIVO	STICKER	AUTOCOLLANT	AUFKLEBER	PEGATINA
0 1704125	1 NR	ADESIVO	DECAL	AUTOCOLLANT	AUFKLEBER	PEGATINA

 ADESIVI
 STICKER
 AUTOCOLLANT

AUFKLEBER 
 PEGATINA 

POS Codice	Q.tà	 Descrizione	 Description	 Designation	 Benennung	 Descripcìon
0 1704277	2 NR	ADESIVO	STICKER	AUTOCOLLANT	AUFKLEBER	PEGATINA
0 06555700	1 NR	ADESIVO	STICKER	AUTOCOLLANT	AUFKLEBER	PEGATINA
0 06555800	1 NR	ADESIVO	STICKER	AUTOCOLLANT	AUFKLEBER	PEGATINA
0 06561200	4 NR	ADESIVO	STICKER	AUTOCOLLANT	AUFKLEBER	PEGATINA
0 06665700	2 NR	ADESIVO POSIZIONE COMANDI DISCESA DI EMERGENZA L=100X90 MM	DECAL	AUTOCOLLANT	AUFKLEBER	AUTOCOLLANT
0 06704400	2 NR	ADESIVO REGOLAZIONE PATTINI SFILO L=120X60 BIANCO (**)	DECAL	AUTOCOLLANT	AUFKLEBER	PEGATINA
0 06706500	1 NR	ADESIVO	STICKER	AUTOCOLLANT	AUFKLEBER	PEGATINA
0 06840400	1 NR	ADESIVO	STICKER	AUTOCOLLANT	AUFKLEBER	PEGATINA
0 06998800	1 NR	ADESIVO	STICKER	AUTOCOLLANT	AUFKLEBER	PEGATINA
0 07058800	2 NR	ADESIVO	STICKER	AUTOCOLLANT	AUFKLEBER	PEGATINA
0 07071000	1 NR	ADESIVO	STICKER	AUTOCOLLANT	AUFKLEBER	PEGATINA
0 07071200	8 NR	ADESIVO	STICKER	AUTOCOLLANT	AUFKLEBER	PEGATINA

AGGIORNATO IL / UPDATED 15/09/2017

**KIT ADESIVI SICUREZZA PER PIATTAFORMA AEREA /
*STICKERS KIT SECURITY FOR AERIAL PLATFORM***

**LIGHT LIFT 15.70 E/AND LIGHT LIFT 13.70
PERFORMANCE IIIS**

Cod. 17787900

+ kit in lingua non incluso nel codice generale / *kit in the language not included in the general code*

**177879IT / 177879GB / 177879FR / 177879DE / 177879ES / 177879NL /
177879SW / 177879PT / 177879DA / 177879NO / 177879RU /
177879PL / 177879SL / 177879FI / 177879CE / 177879JA /**

DA USARE CON / FOR USE WITH

**COD. 17788000 KIT ADESIVI COMMERCIALI PER PIATTAFORMA AEREA / *STICKER KITS COMMERCIAL AERIAL PLATFORM*
LIGHT LIFT 15.70 PERFORMANCE IIIS**

DA USARE CON / FOR USE WITH

**COD. 17844300 KIT ADESIVI COMMERCIALI PER PIATTAFORMA AEREA / *STICKER KITS COMMERCIAL AERIAL PLATFORM*
LIGHT LIFT 13.70 PERFORMANCE IIIS**

**16924900 KIT INTEGRAZIONE ADESIVI PIATTAFORME 3S LITHIUM /
*STICKER KIT INTEGRATION PLATFORM LITHIUM***

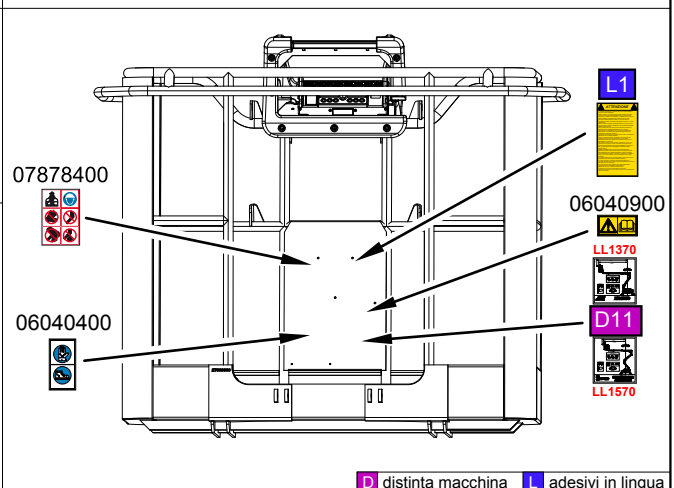
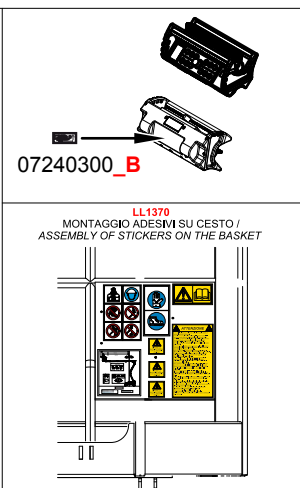
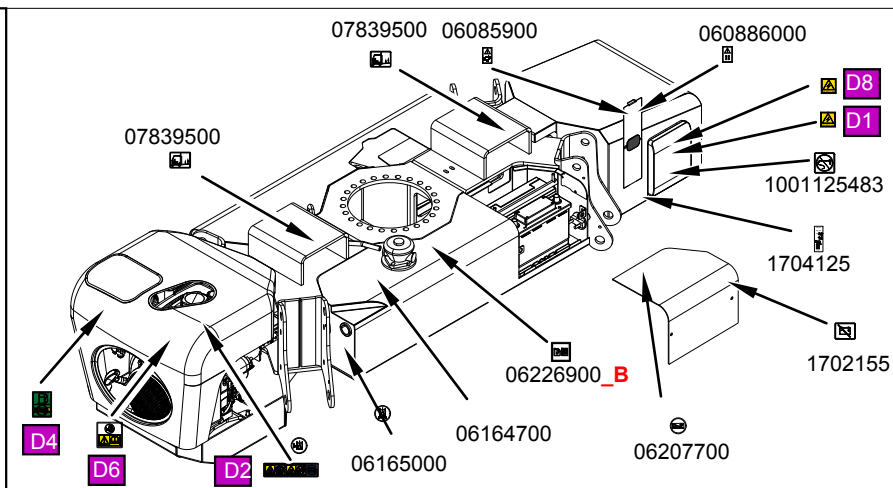
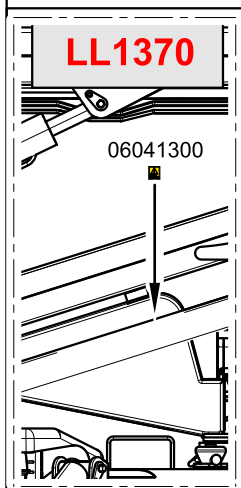
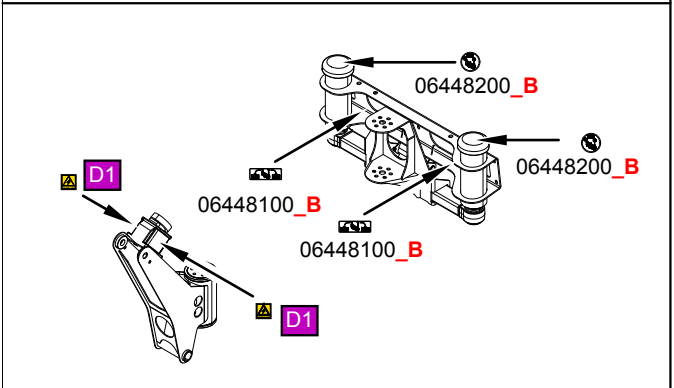
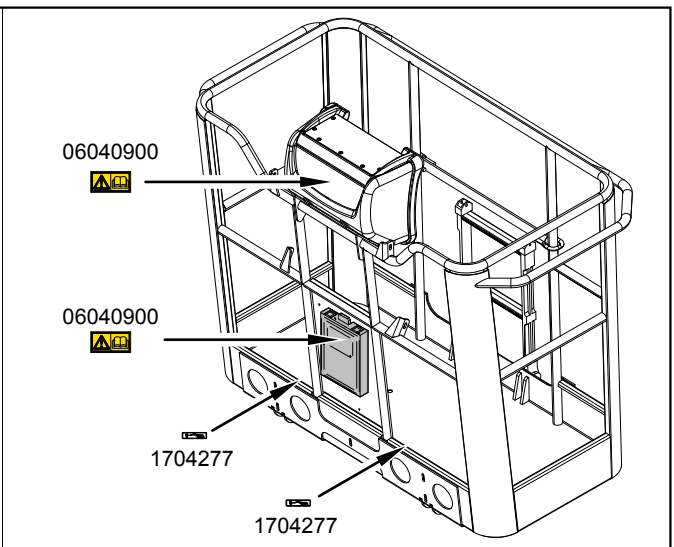
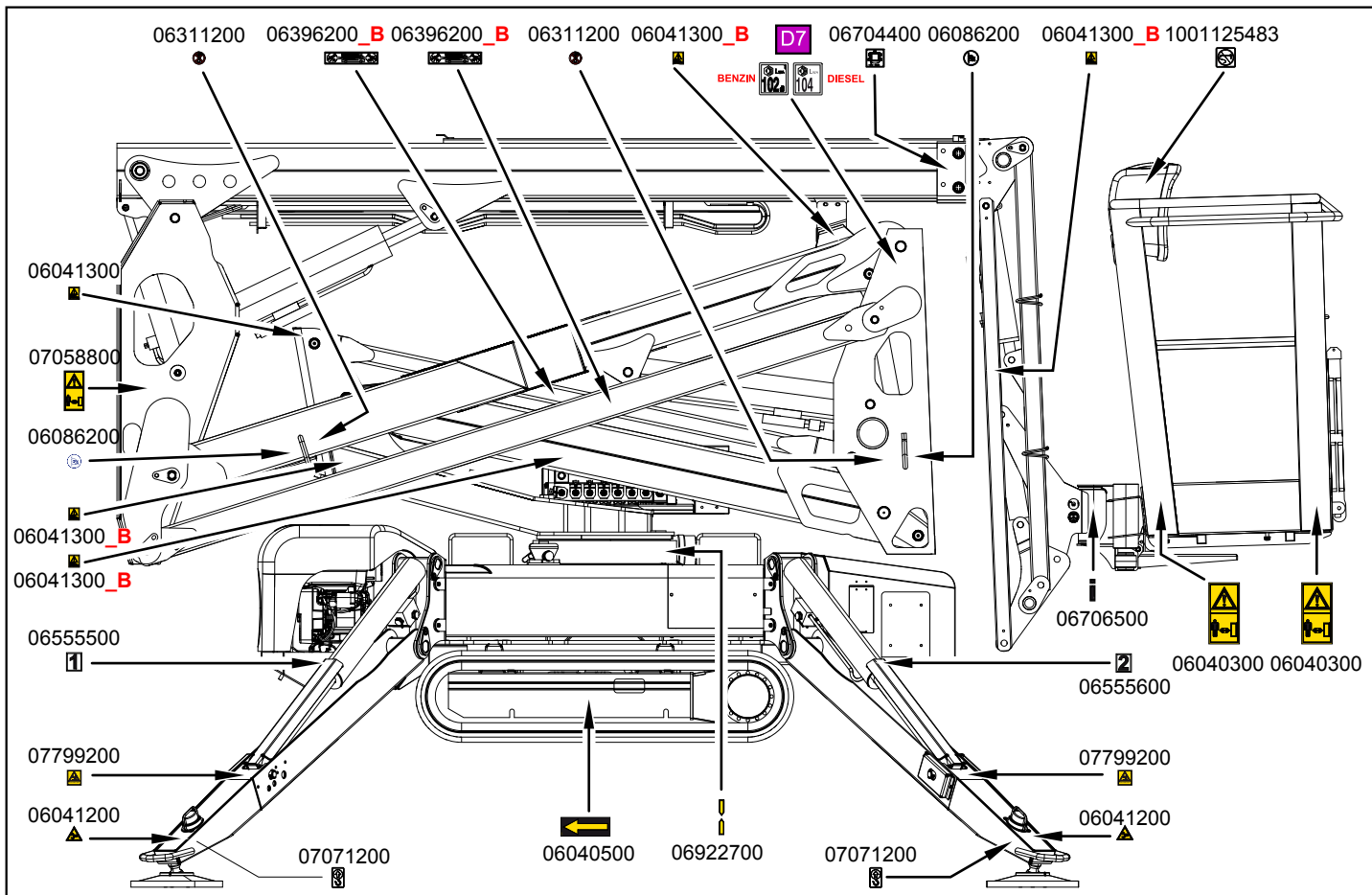

D distinta macchina L adesivi in lingua

KIT ADESIVI LL15.70

SET OF DECALS LL15.70

KIT COLLANTS LL15.70

AUFKLEBERSATZ LL15.70

KIT ADHESIVOS LL15.70

ADHESIEKIT LL15.70

SCALA 1:8

COD. 17787900

TAV. 01

A1

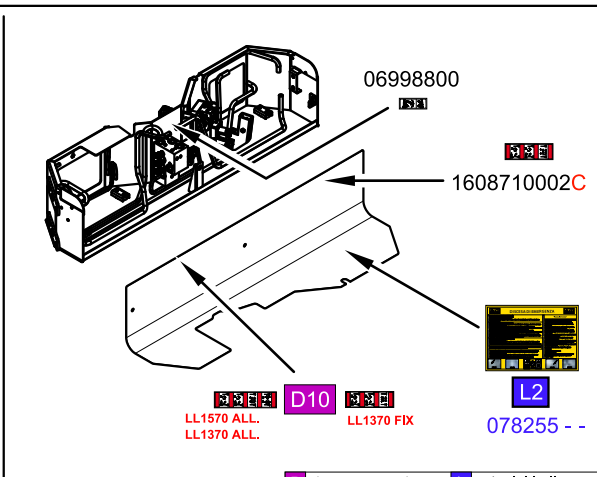
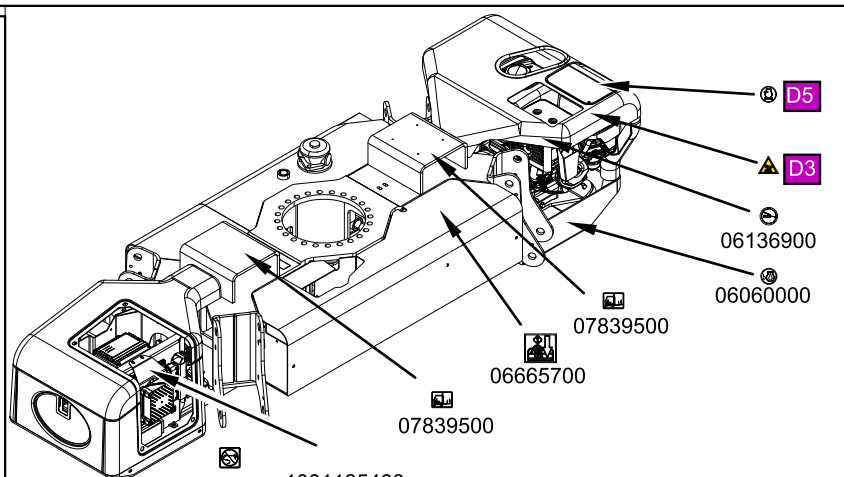
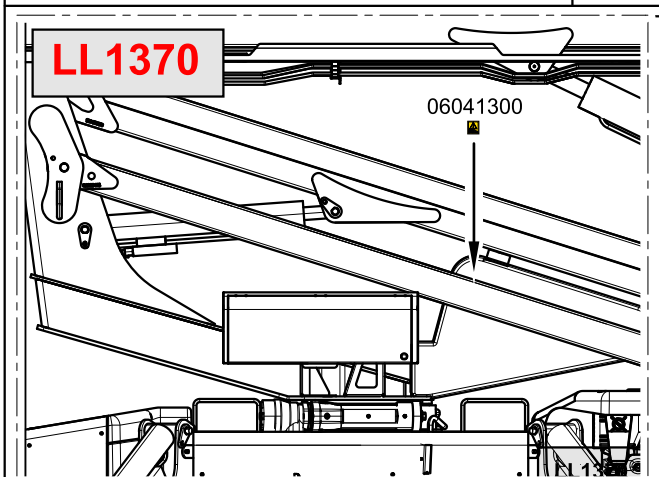
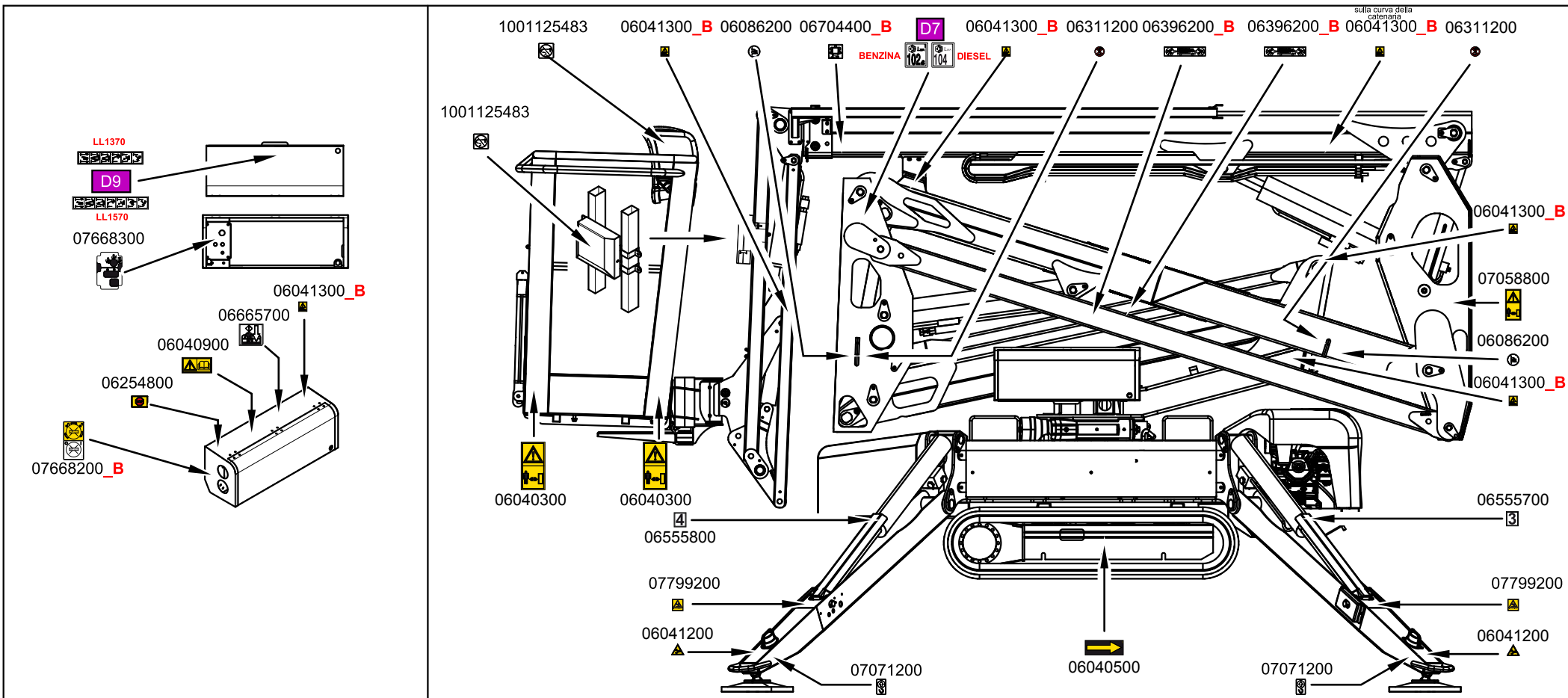

COD. 17787900 ADESIVI IN DISTINTA MACCHINA / STICKERS IN THE MACHINE LIST

VOLT

Num.	COD.	DESCRIZIONE / DESCRIPTION	Q.tà
D1	06042400	ADESIVO PERICOLO 110 VOLT 16A GIALLO _MOD_B	3
D1	06257300	ADESIVO PERICOLO 240 VOLT GIALLO L=47 X 47 MM	3
D1	06561200	ADESIVO PERICOLO 230 VOLT 16 AMPERE GIALLO L=47X47 MM _MOD_B	3
D2	06232100	ADESIVO ATTENZIONE BENZINA INFIAMMABILE L=170X42 MM _MOD_B	1
D3	06056300	ADESIVO PERICOLO SCOTTATURE TRIANGOLARE SFONDO GIALLO	1
D4	06041600	ADESIVO CARBURANTE BENZINA COLORE VERDE L=60 X 80 MM _MOD_B	1
D4	06043900	ADESIVO CARBURANTE DIESEL SFONDO BIANCO Ø 50 MM	1
D5	06164600	ADESIVO FILTRO ARIA SFONDO BIANCO Ø50 MM	1
D6	06227200	ADESIVO CONTROLLARE LIVELLO OLIO MOTORE L=80X80 MM _MOD_B	1
D7	07802200	ADESIVO RUMORE 102 dB L=90X100 MM (MOTORE BENZINA)	2
	07034200	ADESIVO RUMORE 104 dB L=90X100 MM (MOTORE DIESEL _MOD_B	
D8	07668000	ADESIVO PERICOLO 110 VOLT 32A GIALLO L=47 X 47 MM	1
D9	07668100	ADESIVO PULSANTI DISTRIBUTORE PARTE AEREA LL2614 L=318X52 MM - (PER 1570)	1
	07864500	ADESIVO PULSANTI DISTRIBUTORE PARTE AEREA LL13.70 L=274X52 MM - (PER 1370)	1
D10	1608710001	ADESIVO PULSANTI DISTRIBUTORE A TERRA LATO SX GL17.80 L= 194X50 MM _MOD_C - (PER 1570)	1
	07864600	ADESIVO PULSANTI DISTRIBUTORE A TERRA LATO SX LL13.70 L= 150X50 MM - (PER 1370)	1
D11	07799100	ADESIVO PORTATA CESTO 2 PERSONE LL1570 L=135X145 MM	1
	07865900	ADESIVO PORTATA CESTO 2 PERSONE LL1370 L=135X145 MM	1

COD. 17787900 ELENCO ADESIVI / LIST STICKERS

---	COD.	DESCRIZIONE / DESCRIPTION	Q.tà
	06040300	ADESIVO PERICOLO MANTENERE LE DISTANZE GIALLO L=100 X 200 MM	04
	06040400	ADESIVO USARE GUANTI SCARPE CUFFIE L=83 X 160 MM	1
	06040500	ADESIVO DIREZ. TRASLAZIONE FRECCIA GIALLA SFONDO NERO L=61 X 160 MM	2
	06040900	ADESIVO LEGGERE IL MANUALE L=125 X 65 MM GIALLO	4
	06041200	ADESIVO SCHIACCIAMENTO PIEDI TRIANGOLARE L=53X46 MM GIALLO	4
	06041300	ADESIVO ATTENZIONE PERICOLO TAGLI L=35 X 40 MM GIALLO _MOD_B	13
	06060000	ADESIVO LIVELLO OLIO MOTORE Ø50 MM	1
	06085900	ADESIVO SISTEMA BYPASS PARTE AEREA L=30X50	1
	06086000	ADESIVO SISTEMA BYPASS TRASLAZIONE L=30X50 (**)	1
	06086200	ADESIVO ANELLO ATTACCO ANCORAGGIO Ø 50 COLORE BLU	4
	06086600	ADESIVO PERICOLO MANTENERE DISTANZA DI SICUREZZA GIALLO L=65X125 MM	2
	06136900	ADESIVO PUNTI INGRASSAGGIO Ø 55 TESTO NERO - SFONDO BIANCO	1
	06164700	ADESIVO FILTRO OLIO IDRAULICO Ø50 MM BIANCO	1
	06165000	ADESIVO LIVELLO OLIO IDRAULICO Ø50 MM SFONDO BIANCO	1
	06207700	ADESIVO BATTERIA POLO POSITIVO POLO NEGATIVO BIANCO Ø50	1
	06226900	ADESIVO OLIO IDRAULICO SFONDO BIANCO L=60X60 MM _MOD_B	1
	06254800	ADESIVO STOP EMERGENZA SFONDO GIALLO L=70X50 MM _MOD_B	1
	06311200	ADESIVO VIETATO SOLLEVARE DA QUESTO PUNTO Ø 40 (**)	4
	06396200	ADESIVO NON FISSARE NESSUNA CORDA SUI TIRANTI L=175X40MM _MOD_B	4
	06448100	ADESIVO RIPRISTINARE I TAPPI FERMO GUIDA L= 100X35 MM _MOD_B	2
	06448200	ADESIVO "SBLOCCARE SOLO NEI CASI PREVISTI" Ø 60 MM _MOD_B	2
	06555500	ADESIVO NR 1 L=50X60 MM BIANCO	1
	06555600	ADESIVO NR 2 L=50X60 MM BIANCO	1
	06555700	ADESIVO NR 3 L=50X60 MM BIANCO (**)	1

COD. 17787900 ELENCO ADESIVI / LIST STICKERS

---	COD.	DESCRIZIONE / DESCRIPTION	Q.tà
	06555800	ADESIVO NR 4 L=50X60 MM BIANCO	1
	06665700	ADESIVO POSIZIONE COMANDI DISCESA DI EMERGENZA L=100X90 MM	2
	06704400	ADESIVO REGOLAZIONE PATTINI SFILO BIANCO _MOD_B	2
	06706500	ADESIVO ALLINEAMENTO CESTO (2 PEZZI) L=16X50+13(**)	1
	06998800	ADESIVO DEVIATORE POMPA MANUALE PIATTAFORMA GL17. 80XL L=86X34 MM	1
	07071200	ADESIVO JLG PUNTO DI SOLLEVAMENTO L= 40X66 MM	8
	07058800	ADESIVO PERICOLO MANTENERE LE DISTANZE L=65X130 MM - GIALLO	2
	07240300	ADESIVO DISTANZA 1 METRO SU TELE/RADIO COMANDI L= 75x35 MM _MOD_B	1
	07668200	ADESIVO EMERGENCY STOP E BLOCCHETTO ACCENSIONE L= 85x160 MM _MOD_B	1
	07668300	ADESIVO SELETTORE SCATOLA COMANDI TERRA / CESTO L= 105X155 MM	1
	07799200	ADESIVO REAZIONE AL SUOLO STABILIZZATORI LL1570 1670 daN L=45x48 MM	4
	07839500	ADESIVO SOLLEVAMENTO PIATTAFORMA CON MULETTO - PICCOLO L=65X50 MM	4
	07878400	ADESIVO CASCO IMBRAGATURA E DIVIETI LL1370 L=175X118 MM	1
	1001125483	ADESIVO JLG VIETATO LAVARE L=63,5X63,5 MM	5
	1608710002	ADESIVO PULSANTI DISTRIBUTORE A TERRA LATO DX GL17.80 L L=150X50 MM _MOD_C - (PER 1570)	1
	1702155	ADESIVO JLG STACCABATTERIA L= 63,5X50,80 MM	1
	1704125	ADESIVO JLG ATTACCO ARIA E OLIO L=25,4X76,2 MM	1
	1704277	ADESIVO JLG ATTACCO CINTURE DI SICUREZZA L= 76,2X19,05 MM	2
		PER MACCHINE CON CESTO A 1 PERSONA / FOR MACHINE WITH BASKET 1 PERSONA	
	07799300	ADESIVO JLG PORTATA CESTO 1 PERSONA LL15.70 L=135X145 MM “ non in distinta “	1

ELENCO ADESIVI IN LINGUA / LIST LANGUAGE STICKERS**COD. / CODE 177879IT_GB_FR_DE_ES_NL_SW_PT_DA_NO_RU_PL_SL_FI_CE_JA**

Num.	COD.	DESCRIZIONE / DESCRIPTION	Q.tà
	177879IT	ADESIVI IN LINGUA PER LIGHT LIFT 15.70 PERFORMANCE IIIS - LINGUA ITALIANO	
L1	06555300	ADESIVO USO PIATTAFORMA AEREA CINGOLATA - ITALIANO L=128X230 _MOD_C	01
L2	078255IT	ADESIVO DISCESA DI EMERG. LL15.70 MOTORE TERMICO E LITHIUM - ITALIANO L=290X205 MM	01
	177879GB	ADESIVI IN LINGUA PER LIGHT LIFT 15.70 PERFORMANCE IIIS - LINGUA INGLESE	
L1	06562600	ADESIVO USO PIATTAFORMA AEREA CINGOLATA - INGLESE L=128X230 _MOD_C	01
L2	078255GB	ADESIVO DISCESA DI EMERG. LL15.70 MOTORE TERMICO E LITHIUM - INGLESE L=290X205 MM	01
	177879FR	ADESIVI IN LINGUA PER LIGHT LIFT 15.70 PERFORMANCE IIIS - LINGUA FRANCESE	
L1	06562700	ADESIVO USO PIATTAFORMA AEREA CINGOLATA - FRANCESE L=128X230 _MOD_C	01
L2	078255FR	ADESIVO DISCESA DI EMERG. LL15.70 MOTORE TERMICO E LITHIUM - FRANCESE L=290X205 MM	01
	177879DE	ADESIVI IN LINGUA PER LIGHT LIFT 15.70 PERFORMANCE IIIS - LINGUA TEDESCO	
L1	06562800	ADESIVO USO PIATTAFORMA AEREA CINGOLATA - TEDESCO L=128X230 _MOD_C	01
L2	078255DE	ADESIVO DISCESA DI EMERG. LL15.70 MOTORE TERMICO E LITHIUM - TEDESCO L=290X205 MM	01
	177879ES	ADESIVI IN LINGUA PER LIGHT LIFT 15.70 PERFORMANCE IIIS - LINGUA SPAGNOLO	
L1	06562900	ADESIVO USO PIATTAFORMA AEREA CINGOLATA - SPAGNOLO L=128X230 _MOD_C	01
L2	078255ES	ADESIVO DISCESA DI EMERG. LL15.70 MOTORE TERMICO E LITHIUM - SPAGNOLO L=290X205 MM	01
	177879NL	ADESIVI IN LINGUA PER LIGHT LIFT 15.70 PERFORMANCE IIIS - LINGUA OLANDESE	
L1	06563000	ADESIVO USO PIATTAFORMA AEREA CINGOLATA - OLANDESE L=128X230 _MOD_C	01
L2	078255NL	ADESIVO DISCESA DI EMERG. LL15.70 MOTORE TERMICO E LITHIUM - OLANDESE L=290X205 MM	01

ELENCO ADESIVI IN LINGUA / LIST LANGUAGE STICKERS

COD. / CODE 177879IT_GB_FR_DE_ES_NL_SW_PT_DA_NO_RU_PL_SL_FI_CE_JA

NR.	COD.	DESCRIZIONE / DESCRIPTION	Q.tà
	177879SW	ADESIVI IN LINGUA PER LIGHT LIFT 15.70 PERFORMANCE IIIS - LINGUA SVEDESE	
L1	07137300	ADESIVO USO PIATTAFORMA AEREA CINGOLATA - SVEDESE L= 128X230 MM _MOD_C	01
L2	078255SW	ADESIVO DISCESA DI EMERG. LL15.70 MOTORE TERMICO E LITHIUM - SVEDESE L=290X205 MM	01
	177879PT	ADESIVI IN LINGUA PER LIGHT LIFT 15.70 PERFORMANCE IIIS - LINGUA PORTOGHESE	
L1	06563100	ADESIVO USO PIATTAFORMA AEREA CINGOLATA - PORTOGHESE L=128X230 _MOD_C	01
L2	078255PT	ADESIVO DISCESA DI EMERG. LL15.70 MOTORE TERMICO E LITHIUM - PORTOGHESE L=290X205 MM	01
	177879DA	ADESIVI IN LINGUA PER LIGHT LIFT 15.70 PERFORMANCE IIIS - LINGUA DANESE	
L1	07138100	ADESIVO USO PIATTAFORMA AEREA CINGOLATA - DANESE L= 128X230 MM _MOD_C	01
L2	078255DA	ADESIVO DISCESA DI EMERG. LL15.70 MOTORE TERMICO E LITHIUM - DANESE L=290X205 MM	01
	177879NO	ADESIVI IN LINGUA PER LIGHT LIFT 15.70 PERFORMANCE IIIS - LINGUA NORVEGESE	
L1	07162000	ADESIVO USO PIATTAFORMA AEREA CINGOLATA - NORVEGESE L=128X230 MM _MOD_C	01
L2	078255NO	ADESIVO DISCESA DI EMERG. LL15.70 MOTORE TERMICO E LITHIUM - NORVEGESE L=290X205 MM	01
	177879RU	ADESIVI IN LINGUA PER LIGHT LIFT 1570 PERFORMANCE IIIS - LINGUA RUSSO	
L1	07514800	ADESIVO USO PIATTAFORMA AEREA CINGOLATA - RUSSO L=128X230 MM	01
L2	078255RU	ADESIVO DISCESA DI EMERG. LL15.70 MOTORE TERMICO E LITHIUM - RUSSO L=290X205 MM	01
	177879PL	ADESIVI IN LINGUA PER LIGHT LIFT 15.70 PERFORMANCE IIIS - LINGUA POLACCO	
L1	07506600	ADESIVO USO PIATTAFORMA CINGOLATA LINGUA POLACCO L= 128X230MM _MOD_B	01
L2	078255PL	ADESIVO DISCESA DI EMERGENZA LL15.70 MOTORE TERMICO E LITHIUM - POLACCO L=290X205 MM	01

F gwci riq'f kuvpvc

distinta 17787900	Descrizione KIT ADESIVI DI SICUREZZA PER PIATTAFORMA AEREA LL1370 E L			quantità componenti percentuale <input type="checkbox"/>	Disegno
Tipo Articolo	Data creazione 05/04/2016	Data ultimo aggiorn 15/09/2017	Unità di misura NR	Nota	

Tipo	Componente	Descrizione	N.F.	Da Espl.	Quantità	Qtà perc.	Un. mis.	Quantità sfridi	Un. mis.	Nota
Articolo	06040300	ADESIVO PERICOLO MANTENERE LE DISTANZE GIALLO L=100 X 200 MM		Si	4,00	0,00	NR	0,00	NR	
Articolo	06040400	ADESIVO USARE GUANTI SCARPE CUFFIE L=83 X 160 MM		Si	1,00	0,00	NR	0,00	NR	
Articolo	06040500	ADESIVO DIREZIONE TRASLAZIONE FRECCIA GIALLA SFONDO NERO L=61 X 160 MM		Si	2,00	0,00	NR	0,00	NR	
Articolo	06040900	ADESIVO LEGGERE IL MANUALE GIALLO L=125 X 65 MM		Si	4,00	0,00	NR	0,00	NR	
Articolo	06041200	ADESIVO SCHIACCIAMENTO PIEDI TRIANGOLARE L=53X46 MM		Si	4,00	0,00	NR	0,00	NR	
Articolo	06041300	ADESIVO ATTENZIONE PERICOLO TAGLI L=35 X 40 MM GIALLO_ MOD_B		Si	13,00	0,00	NR	0,00	NR	
Articolo	06060000	ADESIVO LIVELLO OLIO MOTORE Ø50 MM		Si	1,00	0,00	NR	0,00	NR	
Articolo	06085900	ADESIVO SISTEMA BYPASS PARTE AEREA L=30X50 MM		Si	1,00	0,00	NR	0,00	NR	
Articolo	06086000	ADESIVO SISTEMA BYPASS TRASLAZIONE L=30X50 MM (**)		Si	1,00	0,00	NR	0,00	NR	
Articolo	06086200	ADESIVO ANELLO ATTACCO ANCORAGGIO Ø 50 COLORE BLU		Si	4,00	0,00	NR	0,00	NR	
Articolo	06136900	ADESIVO PUNTI INGRASSAGGIO Ø 55 MM		Si	1,00	0,00	NR	0,00	NR	
Articolo	06164700	ADESIVO FILTRO OLIO IDRAULICO BIANCO Ø50 MM		Si	1,00	0,00	NR	0,00	NR	
Articolo	06165000	ADESIVO LIVELLO OLIO IDRAULICO SFONDO BIANCO Ø50 MM		Si	1,00	0,00	NR	0,00	NR	
Articolo	06207700	ADESIVO BATTERIA POLO POSITIVO POLO NEGATIVO BIANCO Ø50 MM (**)		Si	1,00	0,00	NR	0,00	NR	
Articolo	06226900	ADESIVO OLIO IDRAULICO SFONDO BIANCO L=60X60 MM_MOD_B		Si	1,00	0,00	NR	0,00	NR	
Articolo	06254800	ADESIVO STOP EMERGENZA SFONDO GIALLO L=70X50 MM_MOD_B		Si	1,00	0,00	NR	0,00	NR	
Articolo	06311200	ADESIVO VIETATO SOLLEVARE DA QUESTO PUNTO Ø 40 (**)		Si	4,00	0,00	NR	0,00	NR	
Articolo	06396200	ADESIVO NON FISSARE NESSUNA CORDA SUI TIRANTI L= 175X40MM_MOD_B		Si	4,00	0,00	NR	0,00	NR	
Articolo	06448100	ADESIVO RIPRISTINARE I TAPPI FERMO GUIDA L= 100X35 MM_ MOD_B		Si	2,00	0,00	NR	0,00	NR	
Articolo	06448200	ADESIVO "SBLOCCARE SOLO NEI CASI PREVISTI" Ø 60 MM_MOD_B		Si	2,00	0,00	NR	0,00	NR	
Articolo	06555500	ADESIVO NR 1 BIANCO L=50X60 MM		Si	1,00	0,00	NR	0,00	NR	

F g w c i r t q ' f k u v p v c

distinta 17787900		Descrizione KIT ADESIVI DI SICUREZZA PER PIATTAFORMA AEREA LL1370 E L		quantità componenti percentuale <input type="checkbox"/>	Disegno
Tipo Articolo	Data creazione 05/04/2016	Data ultimo aggiorn 15/09/2017	Unità di misura NR	Nota	

Tipo	Componente	Descrizione	N.F.	Da Espl.	Quantità	Qtà perc.	Un. mis.	Quantità sfridi	Un. mis.	Nota
Articolo	06555600	ADESIVO NR 2 BIANCO L=50X60 MM		Si	1,00	0,00	NR	0,00	NR	
Articolo	06555700	ADESIVO NR 3 BIANCO L=50X60 MM		Si	1,00	0,00	NR	0,00	NR	
Articolo	06555800	ADESIVO NR 4 BIANCO L=50X60 MM		Si	1,00	0,00	NR	0,00	NR	
Articolo	06665700	ADESIVO POSIZIONE COMANDI DISCESA DI EMERGENZA L=100X90 MM		Si	2,00	0,00	NR	0,00	NR	
Articolo	06704400	ADESIVO REGOLAZIONE PATTINI SFILO BIANCO_MOD_B (**)		Si	2,00	0,00	NR	0,00	NR	
Articolo	06706500	ADESIVO ALLINEAMENTO CESTO (2 PEZZI) L=16X50+13(**)		Si	1,00	0,00	NR	0,00	NR	
Articolo	07878400	ADESIVO CASCO IMBRAGATURA E DIVIETI LL1370 L=175X118 MM		Si	1,00	0,00	NR	0,00	NR	
Articolo	06998800	ADESIVO DEVIATORE POMPA MANUALE PIATTAFORMA GL17. 80XL L=86X34 MM		Si	1,00	0,00	NR	0,00	NR	
Articolo	07071200	ADESIVO JLG PUNTO DI SOLLEVAMENTO L= 40X66 MM		Si	8,00	0,00	NR	0,00	NR	
Articolo	07058800	ADESIVO PERICOLO MANTENERE LE DISTANZE L=65X130 MM - GIALLO		Si	2,00	0,00	NR	0,00	NR	
Articolo	07240300	ADESIVO DISTANZA 1 METRO SU TELE/RADIO COMANDI L= 75x35 MM_MOD_B		Si	1,00	0,00	NR	0,00	NR	
Articolo	07668200	ADESIVO EMERGENCY STOP E BLOCCHETTO ACCENSIONE L= 85x160 MM_MOD_B		Si	1,00	0,00	NR	0,00	NR	
Articolo	07668300	ADESIVO SELETTORE SCATOLA COMANDI TERRA / CESTO L= 105X155 MM		Si	1,00	0,00	NR	0,00	NR	
Articolo	07799200	ADESIVO REAZIONE AL SUOLO STABILIZZATORI LL1570 1670 daN L=45x48 MM		Si	4,00	0,00	NR	0,00	NR	
Articolo	07839500	ADESIVO SOLLEVAMENTO PIATTAFORMA CON MULETTO - PICCOLO L=65X50 MM		Si	4,00	0,00	NR	0,00	NR	
Articolo	1001125483	ADESIVO JLG VIETATO LAVARE L=63,5X63,5 MM		Si	5,00	0,00	NR	0,00	NR	
Articolo	1608710002	ADESIVO PULSANTI DISTRIBUTORE A TERRA LATO DX GL17.80 L L=150X50 MM_MOD_C		Si	1,00	0,00	NR	0,00	NR	
Articolo	1702155	ADESIVO JLG STACCABATTERIA L= 63,5X50,80 MM		Si	1,00	0,00	NR	0,00	NR	
Articolo	1704125	ADESIVO JLG ATTACCO ARIA E OLIO L=25,4X76,2 MM		Si	1,00	0,00	NR	0,00	NR	



AGGIORNATO IL / UPDATED 29/07/2016

**KIT ADESIVI COMMERCIALI PER PIATTAFORMA AEREA /
*STICKERS KIT COMMERCIAL FOR AERIAL PLATFORM***

LIGHT LIFT 15.70 PERFORMANCE IIIS

Cod. 17788000

DA USARE CON / FOR USE WITH

**COD. 17787900 KIT ADESIVI DI SICUREZZA PER PIATTAFORMA AEREA / *STICKER KITS SECURITY AERIAL
PLATFORM***

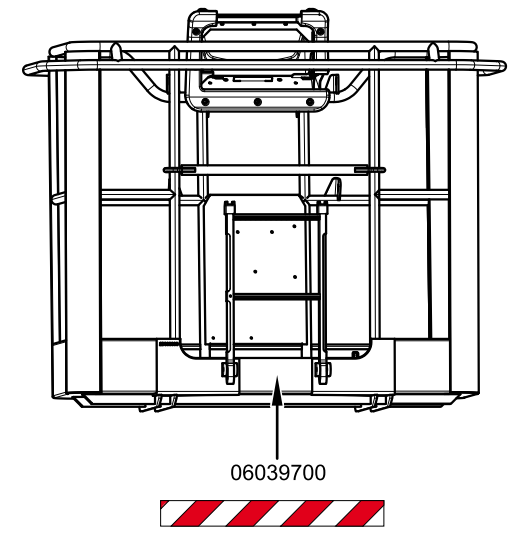
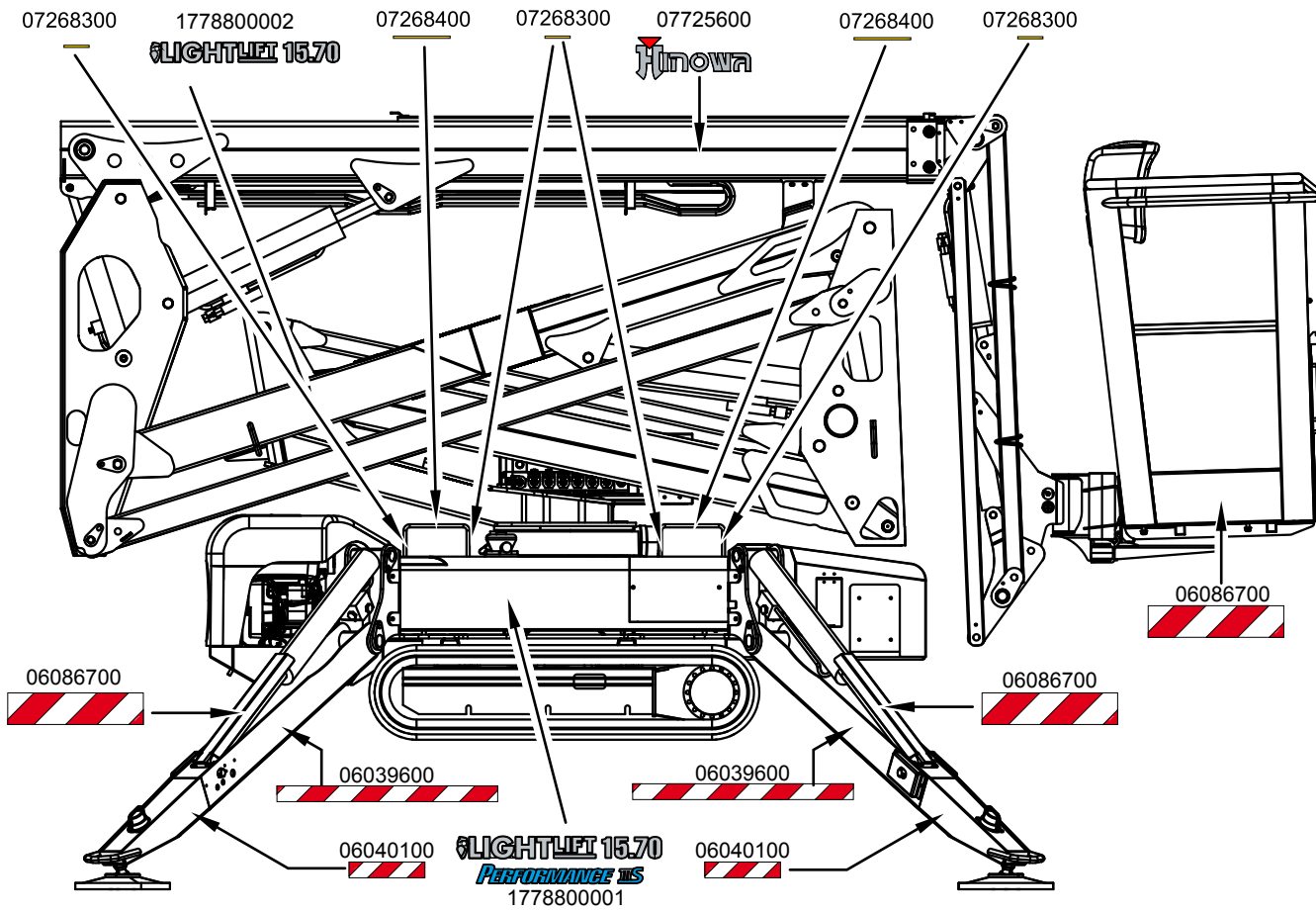





TABELLA PERNI/SPINE (PINS TABLE)

LOCKING SYSTEM
GHIERA
(LOCKNUTS CODE)
REF. TABLE BELOW



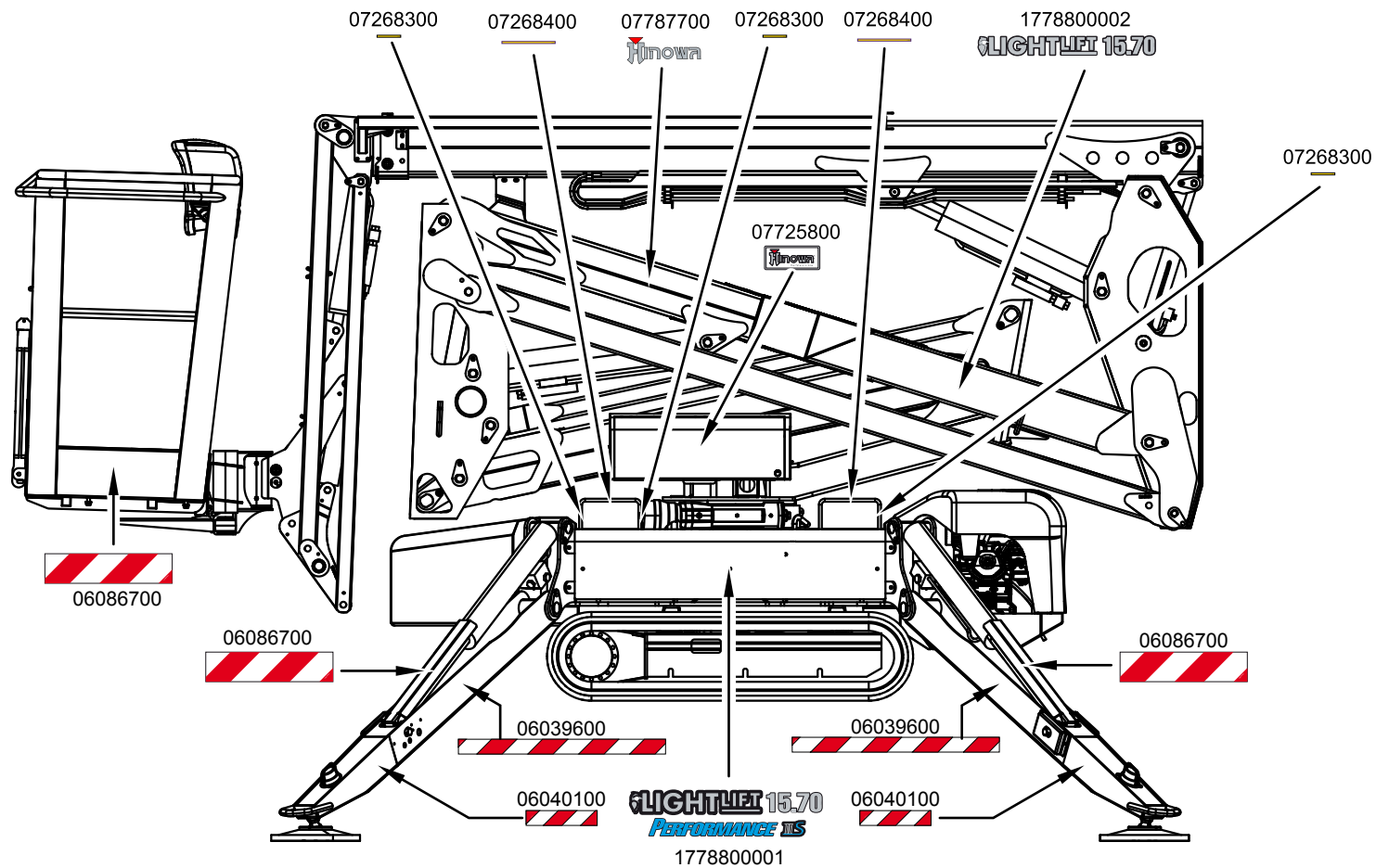
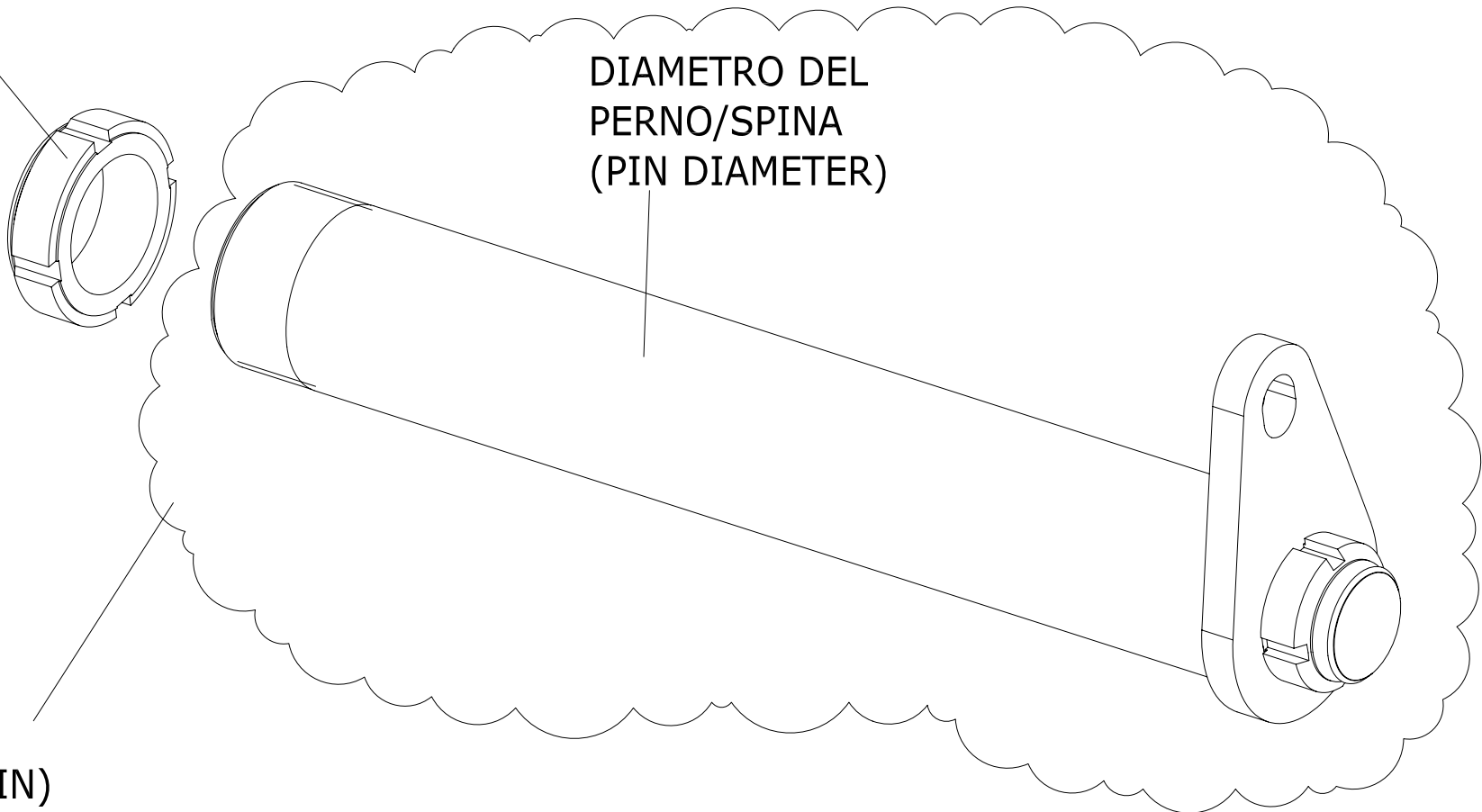

PERNO/SPINA (PIN)



IL CODICE DEL PERNO A RICAMBIO COMPRENDE LA GOCCIA MONTATA E LA GHIERA DI FISSAGGIO DELLA GOCCIA



THE CODE OF A PIN INCLUDES DROP PARTS MOUNTED AND THE LOCK NUT TO FIXING THE DROP, ALL THESE PARTS ARE SHIPPED ALREADY MOUNTED TOGETHER



DIAMETRO DEL PERNO/SPINA mm SISTEMA METRICO (PIN DIAMETER mm METRIC)	GHIERA (LOCKNUTS CODE)	DADO (NUTS CODE)
25	BG4	
30	BG5	
35	BG3	
40	BG2	
45	BG7	
50	BG8	
20 (DIAMETER OF THREADED PART M17 PITCH=1)	BG1	
20 (DIAMETER OF THREADED PART M20 PITCH=1)	BG6	
20 (DIAMETER OF THREADED PART M20 PITCH=1,5)	BG12	



POS	Codice	U.M.	 Descrizione	 Description
BC1	BC000100	NR	COPPIGLIA 4X40	COTTER PIN 4x40
BC2	BC000200	NR	COPPIGLIA 5X40	COTTER PIN 5x40
BC3	BC000300	NR	SEEGER ESTERNO Ø20 GEOMET	SEEGER EXTERNAL Ø20 GEOMET
BC4	BC000400	NR	SEEGER ESTERNO Ø8	SEEGER EXTERNAL Ø8
BC5	BC000500	NR	SEEGER ESTERNO Ø25 GEOMET	SEEGER EXTERNAL Ø25 GEOMET
BC6	BC000600	NR	COPPIGLIA 1,8X8	COTTER PIN 1,8X8
BC7	BC000700	NR	COPPIGLIA 4X55	COTTER PIN 4x55
BC8	BC000800	NR	SEEGER ESTERNO Ø15	SEEGER EXTERNAL Ø15
BC9	BC000900	NR	SEEGER ESTERNO Ø30	SEEGER EXTERNAL Ø30
BD1	BD000100	NR	Dado Esagonale Flangiato Liscio PG DIN 6923 CI 8 M 14 Z.Bianca	Hex Flange Nut DIN 6923 CI Smooth PG 8 M 14 Z. white
BD2	BD000200	NR	Dado Esagonale Basso PG DIN 936 CI 04 M 8 Z.Bianca	Low Hex nut DIN 936 PG 04 M CI 8 Z. white
BD3	BD000300	NR	Dado Esagonale Alto PG UNI 5587 CI 8 M 8 Z.Bianca	Hex Nut High PG UNI 5587 CI 8 M 8 Z. white
BD4	BD000400	NR	Dado Alto Autobloccante PG DIN 982 CI 8 M 12 Z.Bianca	High Self Locking Nut DIN 982 PG 12 CI 8 M Z. white
BD5	BD000500	NR	Dado Alto Autobloccante PG DIN 982 CI 8 M 8 Z.Bianca	High Self Locking Nut DIN 982 PG CI 8 M 8 Z. white
BD6	BD000600	NR	Dado Esagonale Alto PG UNI 5587 CI 8 M 4 Z.Bianca	Hex Nut High PG UNI 5587 M 4 CI 8 Z. white
BD7	BD000700	NR	Dado Esagonale Basso PG DIN 936 CI 04 M 6 Z.Bianca	Low Hex nut DIN 936 PG 6 CI 04 M Z. white
BD8	BD000800	NR	Dado Basso Autobloccante PG DIN 985 CI 8 M 6 Z.Bianca	Low Self-locking nut DIN 985 PG 6 CI 8 M Z. white
BD9	BD000900	NR	Dado Alto Autobloccante PG DIN 982 CI 8 M 6 Z.Bianca	High Self Locking Nut DIN 982 PG CI 8 M6 Z. white

POS	Codice	U.M.	 Descrizione	 Description
BD10	BD001000	NR	Dado Basso Autobloccante PG DIN 985 CI 8 M 5 Z.Bianca	Low Self-locking nut DIN 985 PG CI 8 M5 Z. white
BD11	BD001100	NR	Dado Alto Autobloccante PG DIN 982 CI 8 M 5 Z.Bianca	High Self Locking Nut DIN 982 PG CI 8 M5 Z. white
BD12	BD001200	NR	Dado Alto Autobloccante PG DIN 982 CI 8 M 4 Z.Bianca	High Self Locking Nut DIN 982 PG CI 8 M4 Z. white
BD13	BD001300	NR	Dado Alto Autobloccante PG DIN 982 CI 8 M 3 Z.Bianca	High Self Locking Nut DIN 982 PG CI 8 M3 Z. white
BD14	BD001400	NR	Dado Alto Autobloccante PF DIN 982 CI 8 M 20 x 1,5 Z.Bianca	High Self Locking Nut DIN 982 PF CI 8 M 20 x 1.5 Z white
BD15	BD001500	NR	Dado Alto Autobloccante PG DIN 982 CI 8 M 10 Z.Bianca	High Self Locking Nut DIN 982 PG CI 8 M10 Z. white
BD16	BD001600	NR	Dado Esagonale Alto PG UNI 5587 CI 8 M 3 Z.Bianca	Hex Nut High PG UNI 5587 CI 8 M3 Z. white
BD17	BD001700	NR	Dado Basso Autobloccante PG DIN 985 CI 8 M 8 Z.Bianca	Low Self-locking nut DIN 985 PG CI 8 M8 Z. white
BD18	BD001800	NR	Dado Alto Autobloccante PG DIN 982 CI 8 M 16 Z.Bianca	High Self Locking Nut DIN 982 PG CI 8 M16 Z. white
BD22	BD002200	NR	Dado Alto Autobloccante PG DIN 982 CI 8 M 14 Z.Bianca	Hex Flange Nut DIN 982 CI 8 M 14 Z. white
BD23	BD002300	NR	Dado Basso Autobloccante PG DIN 985 CI 8 M 10 Z.Bianca	Low Self-locking nut DIN 985 PG CI 8 M 10 Z. white
BD24	BD002400	NR	Dado Alto Autobloccante PG DIN 982 CI 8 M 24 Z.Bianca	High Self Locking Nut DIN 982 PG CI 8 M24 Z. white
BD25	BD002500	NR	Dado Esagonale Alto PG UNI 5587 CI 8 M 6 Z.Bianca	Hex Nut High PG UNI 5587 M 6 CI 8 Z. white
BD26	BD002600	NR	Dado Esagonale Alto PG UNI 5587 CI 10 M 10 Z.Bianca	Hex Nut High PG UNI 5587 M 10 CI 10 Z. white
BD27	BD002700	NR	Dado Alto Autobloccante PG DIN 982 CI 8 M 18 Z.Bianca	High Self Locking Nut DIN 982 PG CI 8 M18 Z. white
BD28	BD002800	NR	Dado Basso Autobloccante PG DIN 985 CI 8 M 16 Z.Bianca	Low Self-locking nut DIN 985 PG CI 8 M 16 Z. white
BD29	BD002900	NR	Dado Esagonale Alto PG UNI 5587 CI 8 M 5 Z.Bianca	Hex Nut High PG UNI 5587 M 5 CI 8 Z. white
BD30	BD003000	NR	Dado Esagonale Alto PG UNI 5587 CI 12 M 5 Z.Bianca	Hex Nut High PG UNI 5587 M 5 CI 12 Z. white

POS	Codice	U.M.	 Descrizione	 Description
BD31	BD003100	NR	Dado Esagonale Alto PG UNI 5587 CI 16 M 5 Z.Bianca	Hex Nut High PG UNI 5587 M 5 CI 16 Z. white
BD32	BD003200	NR	Dado Alto Autobloccante PG DIN 982 CI 8 M 20 Z.Bianca	High Self Locking Nut DIN 982 PG CI 8 M20 Z. white
BD33	BD003300	NR	Dado Basso Autobloccante PG DIN 985 CI 8 M 12 Z.Bianca	Low Self-locking nut DIN 985 PG CI 8 M 12 Z. white
BG1	BG000100	NR	Ghiera autobloccante GN CI 6 GN 3 D. 17 x 1 Z.Bianca	Self-locking nut GN GN 3 CI 6 D. 17 x 1 Z. white
BG2	BG000200	NR	Ghiera autobloccante pesante CI 6 GUP 40 x 1,5 Z.Bianca	Self-locking nut heavy CI 6 GUP 40 x 1.5 Z white
BG3	BG000300	NR	Ghiera autobloccante pesante CI 6 GUP 35 x 1,5 Z.Bianca	Self-locking nut heavy CI 6 GUP 35 x 1.5 Z white
BG4	BG000400	NR	Ghiera autobloccante pesante CI 6 GUP 25 x 1,5 Z.Bianca	Self-locking nut heavy CI 6 GUP 25 x 1.5 Z white
BG5	BG000500	NR	Ghiera autobloccante pesante CI 6 GUP 30 x 1,5 Z.Bianca	Self-locking nut heavy CI 6 GUP 30 x 1.5 Z white
BG6	BG000600	NR	Ghiera autobloccante pesante CI 6 GUP 20 x 1 Z.Bianca	Self-locking nut heavy CI 6 GUP 20 x 1 Z. white
BG7	BG000700	NR	Ghiera autobloccante GN CI 6 GN 3 D. 45 x 1,5 Z.Bianca	NUT
BG8	BG000800	NR	Ghiera autobloccante GN CI 6 GN 3 D. 50 x 1,5 Z.Bianca	NUT
BG9	BG000900	NR	Ghiera autobloccante GN CI 6 GN 3 D. 20 x 1,5 Z.Bianca	NUT
BG10	BG001000	NR	Ghiera autobloccante ribassata CI 6 GUK 25 x 1,5 Z.Bianca	Self-locking nut lowered CI 6 GUK 25 x 1.5 Z.Bianca
BG11	BG001100	NR	Ghiera autobloccante ribassata CI 6 GUK 20 x 1 Z.Bianca	Self-locking nut lowered CI 6 GUK 20 x 1 Z.Bianca
BG12	BG001200	NR	Ghiera autobloccante ribassata CI 6 GUA 20 x 1.5 Z.Bianca	Self-locking nut lowered CI 6 GUA 20 x 1.5 Z.Bianca
BG13	BG001300	NR	Ghiera autobloccante ribassata CI 6 GUK 30 x 1.5 Z.Bianca	Self-locking nut lowered CI 6 GUK 30 x 1.5 Z.Bianca
BG14	BG001400	NR	Ghiera autobloccante ribassata CI 6 GUK 45 x 1.5 Z.Bianca	Self-locking nut lowered CI 6 GUK 45 x 1.5 Z.Bianca
BG15	BG001500	NR	Ghiera autobloccante ribassata CI 6 GUK 50 x 1.5 Z.Bianca	Self-locking nut lowered CI 6 GUK 50 x 1.5 Z.Bianca

POS	Codice	U.M.	 Descrizione	 Description
BG16	BG001600	NR	Ghiera autobloccante ribassata CI 6 GUK 55 x 1.5 Z.Bianca	Self-locking nut lowered CI 6 GUK 55 x 1.5 Z.Bianca
BI1	BI000100	NR	INSERTO ESAGONALE M6	INSERT HEX M6
BI2	BI000200	NR	INSERTO ESAGONALE M5	INSERT HEX M5
BI3	BI000300	NR	INSERTO CILINDRICO M4	INSERT M4
BI4	BI000400	NR	INSERTO CILINDRICO M6	INSERT M6
BI5	BI000500	NR	INSERTO ESAGONALE M8	INSERT HEX M8
BI6	BI000600	NR	INSERTO ESAGONALE M4	INSERT HEX M4
BR1	BR000100	NR	Grower sez.rett.spigoli vivi pesante UNI 9195 Acc.Molle D 6 Z.D.Bianca	Grower sez.rett. sharp heavy UNI 9195 Acc.Molle D 6 Z.D. white
BR2	BR000200	NR	Rondella Piana DIN 125-A HV100 D 4 Z.Bianca	Plain washer DIN 125-A HV100 D 4 Z. white
BR3	BR000300	NR	Rondella Piana DIN 125-A HV100 D 5 Z.Bianca	Plain washer DIN 125-A HV100 D 5 Z. white
BR4	BR000400	NR	Rondella Piana DIN 125-A HV100 D 6 Z.Bianca	Plain washer DIN 125-A HV100 D 6 Z. white
BR5	BR000500	NR	Rondella Piana DIN 125-A HV100 D 8 Z.Bianca	Plain washer DIN 125-A HV100 D 8 Z. white
BR6	BR000600	NR	Rondella Piana DIN 125-A HV100 D 10 Z.Bianca	Plain washer DIN 125-A HV100 D 10 Z. white
BR7	BR000700	NR	Rondella Piana DIN 125-A HV100 D 12 Z.Bianca	Plain washer DIN 125-A HV100 D 12 Z. white
BR8	BR000800	NR	Rosetta piana fascia larga e=3d DIN 9021 HV100 D 10 x 30 x 2,5 Z.Bianca	Wide band and flat washer DIN 9021 HV100 3d = D 10 x 30 x 2.5 Z white
BR9	BR000900	NR	Rosetta piana fascia larga e=3d DIN 9021 HV100 D 12 x 36 x 2,5 Z.Bianca	Wide band and flat washer DIN 9021 HV100 3d = D 12 x 36 x 2.5 Z white
BR10	BR001000	NR	Rondella x Carpenteria DIN 6916 HV 300 D 16 Z.Bianca	Carpentry washer DIN 6916 HV 300 D 16 Z white



POS	Codice	U.M.	 Descrizione	 Description
BR11	BR001100	NR	Rosette speciali HV100 D 25 x 51 x 1 Z.Bianca	Special washers HV100 D 25 x 51 x 1 Z. white
BR13	BR001300	NR	Rondella dentellatura esterna DIN 6798-A Acc.Molle D 3 Z.D.Bianca	Washer external serration DIN 6798-A Acc.Molle D 3 ZD white
BR14	BR001400	NR	Rosetta piana fascia larga e=3d DIN 9021 HV100 D 5 x 15 x 1,2 Z.Bianca	Wide band and flat washer DIN 9021 HV100 3d = D 5 x 15 x 1.2 Z whit
BR15	BR001500	NR	Rosetta piana fascia larga e=3d DIN 9021 HV100 D 6 x 18 x 1,5 Z.Bianca	Wide band and flat washer DIN 9021 HV100 3d = D 6 x 18 x 1.5 Z white
BR16	BR001600	NR	Rosetta piana fascia larga e=3d DIN 9021 HV100 D 8 x 24 x 2 Z.Bianca	Wide band and flat washer DIN 9021 HV100 3d = D 8 x 24 x 2 Z. white
BR17	BR001700	NR	Rosetta piana fascia larga e=3d DIN 9021 HV100 D 4 x 12 x 1 Z.Bianca	Wide band and flat washer DIN 9021 HV100 D = 3d 4 x 12 x 1 Z. white
BR18	BR001800	NR	Rondella Piana DIN 125-A NYLON D 4	Plain washer DIN 125-A NYLON D 4
BR19	BR001900	NR	Rondella Piana DIN 125-A HV100 D 3 Z.Bianca	Plain washer DIN 125-A HV100 D 3 Z. white
BR20	BR002000	NR	Rondella Piana DIN 125-A HV100 D 16 Z.Bianca	Plain washer DIN 125-A HV100 D 16 Z. white
BR21	BR002100	NR	Rosetta piana fascia larga e=3d DIN 9021 HV100 D 16 x 48 x 4 Z.Bianca	Wide band and flat washer DIN 9021 HV100 3d = D 16 x 48 x 4 Z. white
BR22	BR002200	NR	Grower sez.rett.spigoli vivi pesante UNI 9195 Acc.Molle D 8 Z.D.Bianca	Grower section. rect. sharp heavy UNI 9195 Stainless Springs D 8 Z.D. white
BR23	BR002300	NR	Rosetta piana fascia larga e=3d DIN 9021 HV100 D 3 x 12 x 1 Z.Bianca	Wide band and flat washer DIN 9021 HV100 D = 3d 3 x 12 x 1 Z. white
BR24	BR002400	NR	Rosetta piana fascia larga e=3d DIN 9021 HV100 D 14 x 42 x 3 Z.Bianca	Wide band and flat washer DIN 9021 HV100 D = 3d 14 x 42 x 3 Z. white
BR25	BR002500	NR	Grower sez.rett.spigoli vivi pesante UNI 9195 Acc.Molle D 10 Z.D.Bianca	Grower sez.rett. sharp heavy UNI 9195 Acc.Molle D 10 Z.D. white
BR26	BR002600	NR	Rondella Piana DIN 125-A D 30 Z.Bianca	Plain washer DIN 125-A D 30 Z. white
BR27	BR002700	NR	Rondella Piana DIN 125-A HV100 D 14 Z.Bianca	Plain washer DIN 125-A HV100 D 14 Z. white



POS	Codice	U.M.	 Descrizione	 Description
BR28	BR002800	NR	Rosetta piana fascia larga D 6 x 24 x 2 Z.Bianca	Wide band and flat washer D 6 x 24 x 2 Z white
BR29	BR002900	NR	Rondella Piana DIN 125-A HV100 D 18 Z.Bianca	Plain washer DIN 125-A HV100 D 18 Z. white
BR30	BR003000	NR	Rondella Piana DIN 125-A HV100 D 20 Z.Bianca	Plain washer DIN 125-A HV100 D 20 Z. white
BR31	BR003100	NR	Grower sez.rett.spigoli vivi pesante UNI 9195 Acc.Molle D 12 Z.D.Bianca	Grower sez.rett. sharp heavy UNI 9195 Acc.Molle D 12 Z.D. white
BR32	BR003200	NR	Rosette speciali HV100 D 30 x 42 x 0.5 Z.Bianca	Special washers HV100 D 30 x 42 x 0.5 Z. white
BR33	BR003300	NR	Rosette speciali HV100 D 30 x 61 x 1 Z.Bianca	Special washers HV100 D 30 x 61 x 1 Z. white
BR34	BR003400	NR	Rosette speciali HV100 D 42 x 52 x 0.2 Z.Bianca	Special washers HV100 D 42 x 52 x 0.2 Z. white
BR35	BR003500	NR	Rosette speciali HV100 D 42 x 52 x 0.3 Z.Bianca	Special washers HV100 D 42 x 52 x 0.3 Z. white
BR36	BR003600	NR	Rosette speciali HV100 D 42 x 52 x 1 Z.Bianca	Special washers HV100 D 42 x 52 x 1 Z. white
BR37	BR003700	NR	Rosette speciali HV100 D 42 x 52 x 1.5 Z.Bianca	Special washers HV100 D 42 x 52 x 1.5 Z. white
BR38	BR003800	NR	Rosette speciali HV100 D 42 x 52 x 2 Z.Bianca	Special washers HV100 D 42 x 52 x 2 Z. white
BR39	BR003900	NR	Rosetta piana fascia larga e=3d DIN 9021 HV100 D 18 x 48 x 4 Z.Bianca	Wide band and flat washer DIN 9021 HV100 3d = D 18 x 48 x 4 Z. white
BR40	BR004000	NR	Rosetta SCHNORR zincate D 6	WASHER
BR41	BR004100	NR	Grower sez.rett.spigoli vivi pesante UNI 9195 Acc.Molle D 14 Z.D.Bianca	Grower sez.rett. sharp heavy UNI 9195 Acc.Molle D 14 Z.D. white
BR42	BR004200	NR	Rondella x Carpenteria DIN 6916 HV 300 D 14 Z.Bianca	Carpentry washer DIN 6916 HV 300 D 14 Z white
BR43	BR004300	NR	Rondella x Carpenteria DIN 125-A HV 300 D 10 Z.Bianca	Carpentry washer DIN 125-A HV 300 D 10 Z white
BR44	BR004400	NR	Rondella x Carpenteria DIN 125-A HV 300 D 20 Z.Bianca	Carpentry washer DIN 125-A HV 300 D 20 Z white

POS	Codice	U.M.	 Descrizione	 Description
BS1	BS000100	NR	GRANO FILETTATO M6X12	SCREW
BS2	BS000200	NR	SPINA CIL. 8x16 UNI 6364-A h6 CMT + TMP	PIN CYLINDER 8 x 16 UNI 6364-A CMT h6 + TMP
BS3	BS000300	NR	PRIGIONIERO M10X35	PIN
BS4	BS000400	NR	SPINA ELASTICA 6X60 UNI 6873	PIN
BS5	BS000500	NR	SPINA ELASTICA 6X14 UNI 6873	PIN
BS6	BS000600	NR	Spina Spirol Normale DIN 7343 INOX A2 D 5x10	PIN
BS7	BS000700	NR	Rivetto alluminio Ø3x12	Aluminum rivet Ø3x12
BV1	BV000100	NR	Vite TE Parziale Filetto PG DIN 931 CI 8.8 M 8 x 80 Z.Bianca	Screw Partial Thread DIN 931 PG CI 8.8 M 8 x 80 Z. white
BV2	BV000200	NR	Vite TE Tutto Filetto PG DIN 933 CI 8.8 M 8 x 60 Z.Bianca	Screw All Thread DIN 933 PG CI 8.8 M 8 x 60 Z. white
BV3	BV000300	NR	Vite TCEI PG DIN 912 CI 8.8 M 8 x 60 Z.Bianca	Screw DIN 912 PG CI 8.8 M8 x 60 Z. white
BV4	BV000400	NR	Vite TE Parziale Filetto PG DIN 931 CI 8.8 M 8 x 50 Z.Bianca	Screw Partial Thread DIN 931 PG CI 8.8 M 8 x 50 Z. white
BV5	BV000500	NR	Vite TCEI PG DIN 912 CI 8.8 M 8 x 45 Z.Bianca	Screw DIN 912 PG CI 8.8 M8 x 45 Z. white
BV6	BV000600	NR	Vite TCEI PG DIN 912 CI 8.8 M 8 x 40 Z.Bianca	Screw DIN 912 PG CI 8.8 M8 x 40 Z.Bianca
BV7	BV000700	NR	Vite TE Tutto Filetto PG DIN 933 CI 8.8 M 8 x 35 Z.Bianca	Screw All Thread DIN 933 PG CI 8.8 M 8 x 35 Z. white
BV8	BV000800	NR	Vite TE Tutto Filetto PG DIN 933 CI 8.8 M 8 x 30 Z.Bianca	Screw All Thread DIN 933 PG CI 8.8 M 8 x 30 Z. white
BV9	BV000900	NR	Vite TE Tutto Filetto PG DIN 933 CI 8.8 M 8 x 25 Z.Bianca	Screw All Thread DIN 933 PG CI 8.8 M 8 x 25 Z. white
BV10	BV001000	NR	Vite TCEI PG DIN 912 CI 8.8 M 8 x 25 Z.Bianca	Screw DIN 912 PG CI 8.8 M8 x 25 Z. white
BV11	BV001100	NR	Vite TE Tutto Filetto PG DIN 933 CI 8.8 M 8 x 20 Z.Bianca	Screw All Thread DIN 933 PG CI 8.8 M 8 x 20 Z. white

POS	Codice	U.M.	 Descrizione	 Description
BV12	BV001200	NR	Vite TE Tutto Filetto PG DIN 933 CI 8.8 M 8 x 16 Z.Bianca	Screw All Thread DIN 933 PG CI 8.8 M 8 x 16 Z. white
BV13	BV001300	NR	Vite TCEI PG DIN 912 CI 8.8 M 8 x 16 Z.Bianca	Screw DIN 912 PG CI 8.8 M8 x 16 Z. white
BV14	BV001400	NR	Vite TE Tutto Filetto PG DIN 933 CI 8.8 M 8 x 14 Z.Bianca	Screw All Thread DIN 933 PG CI 8.8 M 8 x 14 Z. white
BV15	BV001500	NR	Vite TCEI PG DIN 912 CI 8.8 M 6 x 45 Z.Bianca	Screw DIN 912 M6 x 45 CI 8.8 Z. white
BV16	BV001600	NR	Vite TCEI PG DIN 912 CI 8.8 M 6 x 30 Z.Bianca	Screw DIN 912 M6 x 30 CI 8.8 Z. white
BV17	BV001700	NR	Vite TSPEI PG DIN 7991 CI 10.9 M 6 x 30 Z.Bianca	screw DIN 7991 CI 10.9 M 6 x 30 Z. white
BV18	BV001800	NR	Vite TE Tutto Filetto PG DIN 933 CI 8.8 M 6 x 30 Z.Bianca	Screw All Thread DIN 933 PG CI 8.8 M 6 x 30 Z. white
BV19	BV001900	NR	Vite TBEI PG ISO 7380 CI 10.9 M 6 x 30 Z.Bianca	screw ISO 7380 CI 10.9 M 6 x 30 Z. white
BV20	BV002000	NR	Vite TE Tutto Filetto PG DIN 933 CI 8.8 M 6 x 12 Z.Bianca	Screw All Thread DIN 933 PG CI 8.8 M 6 x 12 Z. white
BV21	BV002100	NR	Vite TCEI PG DIN 912 CI 8.8 M 6 x 12 Z.Bianca	Screw DIN 912 PG CI 8.8 M 6 x 12 Z. white
BV22	BV002200	NR	Vite TCEI PG DIN 912 CI 8.8 M 5 x 45 Z.Bianca	Screw DIN 912 PG CI 8.8 M 5 x 45 Z. white
BV23	BV002300	NR	Vite TE UNF ANSI B18.2.1 GR.5 5/16 x 1" Z.Bianca	Screw UNF ANSI B18.2.1 GR.5 5/16 x 1 "Z. White
BV24	BV002400	NR	Vite TC Croce PG DIN 7985 CI 4.8 M 4 x 8 Z.Bianca	Cross head screw DIN 7985 PG CI 4.8 M 4 x 8 Z. white
BV25	BV002500	NR	Vite TCEI PG DIN 912 CI 8.8 M 4 x 16 Z.Bianca	Screw DIN 912 PG CI 8.8 M 4 x 16 Z. white
BV26	BV002600	NR	Vite TCEI PG DIN 912 CI 8.8 M 6 x 50 Z.Bianca	Screw DIN 912 PG CI 8.8 M 6 x 50 Z. white
BV27	BV002700	NR	Vite TSPEI PG DIN 7991 CI 10.9 M 6 x 40 Z.Bianca	screw DIN 7991 CI 10.9 M 6 x 40 Z. white
BV28	BV002800	NR	Vite TSPEI PG DIN 7991 CI 10.9 M 6 x 25 Z.Bianca	screw DIN 7991 CI 10.9 M 6 x 25 Z. white
BV29	BV002900	NR	Vite TE Tutto Filetto PG DIN 933 CI 8.8 M 6 x 25 Z.Bianca	Screw All Thread DIN 933 PG CI 8.8 M 6 x 25 Z. white

POS	Codice	U.M.	 Descrizione	 Description
BV30	BV003000	NR	Vite TE Tutto Filetto PG DIN 933 CI 8.8 M 6 x 22 Z.Bianca	Screw All Thread DIN 933 PG CI 8.8 M 6 x 22 Z. white
BV31	BV003100	NR	Vite TSPEI PG DIN 7991 CI 10.9 M 6 x 20 Z.Bianca	screw DIN 7991 CI 10.9 M 6 x 20 Z. white
BV32	BV003200	NR	Vite TE Tutto Filetto PG DIN 933 CI 8.8 M 6 x 20 Z.Bianca	Screw All Thread DIN 933 PG CI 8.8 M 6 x 20 Z. white
BV33	BV003300	NR	Vite TCEI PG DIN 912 CI 8.8 M 6 x 20 Z.Bianca	Screw DIN 912 PG CI 8.8 M 6 x 20 Z. white
BV34	BV003400	NR	Vite TE Tutto Filetto PG DIN 933 CI 8.8 M 6 x 16 Z.Bianca	Screw All Thread DIN 933 PG CI 8.8 M 6 x 16 Z. white
BV35	BV003500	NR	Vite TBEI PG ISO 7380 CI 10.9 M 6 x 16 Z.Bianca	screw ISO 7380 CI 10.9 M 6 x 16 Z. white
BV36	BV003600	NR	Vite TCEI PG DIN 912 CI 8.8 M 5 x 8 Z.Bianca	Screw DIN 912 PG CI 8.8 M 5 x 8 Z. white
BV37	BV003700	NR	Vite TSPEI PG DIN 7991 CI 10.9 M 5 x 60 Z.Bianca	screw DIN 7991 CI 10.9 M 5 x 60 Z. white
BV38	BV003800	NR	Vite TE Parziale Filetto PG DIN 931 CI 8.8 M 5 x 60 Z.Bianca	Screw Partial Thread DIN 931 PG CI 8.8 M 5 x 60 Z. white
BV39	BV003900	NR	Vite TCEI PG DIN 912 CI 8.8 M 5 x 60 Z.Bianca	Screw DIN 912 PG CI 8.8 M 5 x 60 Z. white
BV40	BV004000	NR	Vite TE Parziale Filetto PG DIN 931 CI 8.8 M 5 x 55 Z.Bianca	Screw Partial Thread DIN 931 PG CI 8.8 M 5 x 55 Z. white
BV41	BV004100	NR	Vite TE Tutto Filetto PG DIN 933 CI 8.8 M 5 x 16 Z.Bianca	Screw All Thread DIN 933 PG CI 8.8 M 5 x 16 Z. white
BV42	BV004200	NR	Vite TC Croce PG DIN 7985 CI 4.8 M 5 x 16 Z.Bianca	Cross head screw DIN 7985 PG CI 4.8 M 5 x 16 Z. white
BV43	BV004300	NR	Vite TE Tutto Filetto PG DIN 933 CI 8.8 M 5 x 12 Z.Bianca	Screw All Thread DIN 933 PG CI 8.8 M 5 x 12 Z. white
BV44	BV004400	NR	Vite TE UNF ANSI B18.2.1 GR.5 5/16 x 1"1/4 Z.Bianca	Screw UNF ANSI B18.2.1 GR.5 5/16 x 1 "1/4 Z. White
BV45	BV004500	NR	Vite TE UNF ANSI B18.2.1 GR.5 5/16 x 1"1/4 Z.Bianca	Screw UNF ANSI B18.2.1 GR.5 5/16 x 1 "1/4 Z. White
BV46	BV004600	NR	Vite TCEI PG DIN 912 CI 8.8 M 4 x 40 Z.Bianca	Screw DIN 912 PG CI 8.8 M 4 x 40 Z. white
BV47	BV004700	NR	Vite Trilob. Autoform. TC Croce PG DIN 7500-C C15 M 4 x 40 Z.Bianca	Trilob Screw. Autoform. TC Cross PH DIN 7500-C C 15 M 4 x 40 Z. white

POS	Codice	U.M.	 Descrizione	 Description
BV48	BV004800	NR	Vite Trilob. Autoform. TC Croce PG DIN 7500-C C15 M 4 x 20 Z.Bianca	Trilob Screw. Autoform. TC Cross PG DIN 7500-C C15 M 4 x 20 Z. white
BV49	BV004900	NR	Vite TC Croce PG DIN 7985 CI 4.8 M 4 x 16 Z.Bianca	Cross head screw DIN 7985 PG CI 4.8 M 4 x 16 Z. white
BV50	BV005000	NR	VITE AUTOFIETTANTE TE C/BORDINO DIN 6928 C15 4,8X50 Z.Bianca	TAPPING SCREW TE C / BORDINO DIN 6928 C15 4.8 X50 Z. white
BV51	BV005100	NR	VITE AUTOFIETTANTE TE C/BORDINO DIN 6928 C15 4,8X25 Z.Bianca	TAPPING SCREW TE C / BORDINO DIN 6928 C15 4.8 X25 Z. white
BV52	BV005200	NR	Vite TCEI PG DIN 912 CI 12.9 M 3 x 25 Z.D.Bianca	Screw DIN 912 M 3 CI 12.9 x 25 Z.D. white
BV53	BV005300	NR	Vite TSPEI PG DIN 7991 CI 10.9 M 3 x 14 Z.Bianca	Screw DIN 7991 CI 10.9 M 3 x 14 Z. white
BV54	BV005400	NR	Vite Autofil.TC Croce DIN 7981 C15 3,5 x 6,5 Z.Bianca	Autofil.TC Cross Screw DIN 7981 C15 3.5 x 6.5 Z. white
BV55	BV005500	NR	Vite TE Parziale Filetto PG DIN 931 CI 10.9 M 16 x 55	Screw Partial Thread DIN 931 PG CI 10.9 M 16 x 55
BV56	BV005600	NR	Vite TE Tutto Filetto PG DIN 933 CI 8.8 M 16 x 40 Z.Bianca	Screw All Thread DIN 933 PG CI 8.8 M 16 x 40 Z. white
BV57	BV005700	NR	Vite TE Parziale Filetto PG DIN 931 CI 10.9 M 16 x 220	Screw Partial Thread DIN 931 PG CI 10.9 M 16 x 220
BV58	BV005800	NR	Vite TE 8.8 DIN933 M16x20 Testa Alta 8 Zn Bianca	Screw M16x20 DIN933 8.8 Head High 8 Zn White
BV59	BV005900	NR	Vite TE Tutto Filetto PG DIN 933 CI 8.8 M 12 x 16 Z.Bianca	Screw All Thread DIN 933 PG CI 8.8 M 12 x 16 Z. white
BV60	BV006000	NR	Vite TE Parziale Filetto PG DIN 931 CI 8.8 M 12 x 120 Z.Bianca	Screw Partial Thread DIN 931 PG CI 8.8 M 12 x 120 Z. white
BV61	BV006100	NR	Vite TE Parziale Filetto PG DIN 931 CI 8.8 M 10 x 50 Z.Bianca	Screw Partial Thread DIN 931 PG CI 8.8 M 10 x 50 Z. white
BV62	BV006200	NR	Vite TE Tutto Filetto PG DIN 933 CI 8.8 M 10 x 35 Z.Bianca	Screw All Thread DIN 933 PG CI 8.8 M 10 x 35 Z. white
BV63	BV006300	NR	Vite TSPEI PG DIN 7991 CI 10.9 M 10 x 30 Z.Bianca	Screw DIN 7991 CI 10.9 M 10 x 30 Z. white
BV64	BV006400	NR	Vite TE Tutto Filetto PG DIN 933 CI 8.8 M 10 x 30 Z.Bianca	Screw All Thread DIN 933 PG CI 8.8 M 10 x 30 Z. white



POS	Codice	U.M.	 Descrizione	 Description
BV65	BV006500	NR	Vite TCEI PG DIN 912 CI 12.9 M 10 x 25 Geo 321 A	Screw DIN 912 PG CI 12.9 M 10 x 25 Geo 321 A
BV66	BV006600	NR	Vite TCEI PG DIN 912 CI 8.8 M 10 x 25 Z.Bianca	Screw DIN 912 PG CI 8.8 M 10 x 25 Z. white
BV67	BV006700	NR	Vite TE Tutto Filetto PG DIN 933 CI 8.8 M 10 x 20 Z.Bianca	Screw All Thread DIN 933 PG CI 8.8 M 10 x 20 Z. white
BV68	BV006800	NR	Vite TE Tutto Filetto PG DIN 933 CI 8.8 M 10 x 18 Z.Bianca	Screw All Thread DIN 933 PG CI 8.8 M 10 x 18 Z. white
BV69	BV006900	NR	Vite Trilob. Autoform. TSP Croce PG DIN 7500-M C15 M 5 x 16 Z.Bianca	Trilob Screw. Autoform. TSP Cross PG DIN 7500-M C15 M 5 x 16 Z. white
BV70	BV007000	NR	Vite TE Parziale Filetto PG DIN 931 CI 8.8 M 8 x 70 Z.Bianca	Screw Partial Thread DIN 931 PG CI 8.8 M 8 x 70 Z. white
BV71	BV007100	NR	Vite TE Parziale Filetto PG DIN 931 CI 8.8 M 8 x 65 Z.Bianca	Screw Partial Thread DIN 931 PG CI 8.8 M 8 x 65 Z. white
BV72	BV007200	NR	Vite TE Parziale Filetto PG DIN 931 CI 8.8 M 6 x 55 Z.Bianca	Screw Partial Thread DIN 931 PG CI 8.8 M 6 x 55 Z. white
BV73	BV007300	NR	Vite TCEI PG DIN 912 CI 8.8 M 6 x 55 Z.Bianca	Screw DIN 912 PG CI 8.8 M 6 x 55 Z. white
BV74	BV007400	NR	Vite TCEI PG DIN 912 CI 8.8 M 6 x 16 Z.Bianca	Screw DIN 912 PG CI 8.8 M 6 x 16 Z. white
BV75	BV007500	NR	Vite TSPEI PG DIN 7991 CI 10.9 M 6 x 10 Z.Bianca	Screw DIN 7991 CI 10.9 M 6 x 10 Z. white
BV76	BV007600	NR	Vite TCEI PG DIN 912 CI 8.8 M 5 x 55 Z.Bianca	Screw DIN 912 PG CI 8.8 M 5 x 55 Z. white
BV77	BV007700	NR	Vite TC Croce PG DIN 7985 CI 4.8 M 6 x 16 Z.Bianca	Cross head screw DIN 7985 PG CI 4.8 M 6 x 16 Z. white
BV78	BV007800	NR	Vite Trilob. Autoform. TC Croce PG DIN 7500-C C15 M 5 x 12 Z.Bianca	Trilob Screw. Autoform. TC Cross PG DIN 7500-C C15 M 5 x 12 Z. white
BV79	BV007900	NR	Vite TE Tutto Filetto PG DIN 933 CI 8.8 M 4 x 35 Z.Bianca	Screw All Thread DIN 933 PG CI 8.8 M 4 x 35 Z. white
BV80	BV008000	NR	VITE AUTOFIETTANTE TE C/BORDINO DIN 6928 C15 4,8X35 Z.Bianca	TAPPING SCREW TE C / BORDINO DIN 6928 C15 4.8 X35 Z. white
BV81	BV008100	NR	Vite TCEI PG DIN 912 CI 12.9 M 3 x 14 Z.D.Bianca	Screw DIN 912 M 3 CI 12.9 x 14 Z.D. white

POS	Codice	U.M.	 Descrizione	 Description
BV82	BV008200	NR	Vite TE Parziale Filetto PG DIN 931 CI 8.8 M 16 x 70 Z.Bianca	Screw Partial Thread DIN 931 PG CI 8.8 M 16 x 70 Z. white
BV83	BV008300	NR	Vite TE Parziale Filetto PG DIN 931 CI 8.8 M 16 x 260 Z.Bianca	Screw Partial Thread DIN 931 PG CI 8.8 M 16 x 260 Z. white
BV84	BV008400	NR	Vite TE Parziale Filetto PG DIN 931 CI 8.8 M 12 x 110 Z.Bianca	Screw Partial Thread DIN 931 PG CI 8.8 M 12 x 110 Z. white
BV85	BV008500	NR	Vite TE Tutto Filetto PG DIN 933 CI 8.8 M 10 x 40 Z.Bianca	Screw Thread DIN 933 PG CI 8.8 M 10 x 40 Z. white
BV86	BV008600	NR	Vite TCEI PG DIN 912 CI 8.8 M 8 x 65 Z.Bianca	Screw DIN 912 PG CI 8.8 M 8 x 65 Z. white
BV87	BV008700	NR	Vite TCEI PG DIN 912 CI 8.8 M 8 x 20 Z.Bianca	Screw DIN 931 PG CI 8.8 M 10 x 40 Z. white
BV88	BV008800	NR	Vite TCEI PG DIN 912 CI 10.9 M 10 x 18 Z.Bianca	Screw DIN 912 PG CI 10.9 M 10 x 18 Z. white
BV89	BV008900	NR	Vite TCEI PG DIN 912 CI 8.8 M 8 x 70 Z.Bianca	Screw DIN 912 PG CI 8.8 M 8 x 70 Z. white
BV91	BV009100	NR	Vite TE Parziale Filetto PG DIN 931 CI 8.8 M 6 x 40 Z.Bianca	Screw Partial Thread DIN 931 PG CI 8.8 M 6 x 40 Z. white
BV92	BV009200	NR	Vite TE Tutto Filetto PG DIN 933 CI 8.8 M 10 x 60 Z.Bianca	Screw All Thread DIN 933 PG CI 8.8 M 10 x 60 Z. white
BV93	BV009300	NR	Vite TSPEI PG DIN 7991 CI 10.9 M 5 x 20 Z.Bianca	screw DIN 7991 CI 10.9 M 5 x 20 Z. white
BV94	BV009400	NR	Vite TC Croce PG DIN 7985 CI 4.8 M 4 x 12 Z.Bianca	Cross head screw DIN 7985 PG CI 4.8 M 4 x 12 Z. white
BV95	BV009500	NR	Vite TE Tutto Filetto PG DIN 933 CI 8.8 M 4 x 12 Z.Bianca	Screw All Thread DIN 933 PG CI 8.8 M 4 x 12 Z. white
BV96	BV009600	NR	Vite TCEI PG DIN 912 CI 12.9 M 12 x 30 Dac 320A	Screw DIN 912 CI 12.9 M 12 x 30 Dac 320A
BV97	BV009700	NR	Vite Autofil.Testa Mezza Tonda C15 4,8 x 13 Z.Bianca	Half Round Head Self Tapping Screw C15 4,8 x 13
BV98	BV009800	NR	Vite TC Croce PG DIN 7985 CI 4.8 M 4 x 14 Z.Bianca	Screw DIN 7985 CI 4.8 M 4 x 14
BV99	BV009900	NR	Vite TE Parziale Filetto PG DIN 931 CI 8.8 M 5 x 65 Z.Bianca	Screw Partial Thread DIN 931 PG CI 8.8 M 5 x 65 Z. white



POS	Codice	U.M.	 Descrizione	 Description
BV100	BV010000	NR	Vite Autofil. Testa Mezza Tonda C15 4,8 x 16 Z.Bianca	Half Round Head Self Tapping Screw C15 4,8 x 16
BV101	BV010100	NR	Vite TSPEI PG DIN 7991 CI 10.9 M 8 x 25 Z.Bianca	screw DIN 7991 CI 10.9 M 8 x 25 Z. white
BV102	BV010200	NR	Vite TCEI PG DIN 912 CI 8.8 M 4 x 30 Z.Bianca	Screw DIN 912 PG CI 8.8 M 4 x 30 White Z
BV103	BV010300	NR	Vite TSPEI PG DIN 7991 CI 10.9 M 5 x 16 Z.Bianca	Screw DIN 7991 CI 10.9 M 5 x 16 Z. white
BV104	BV010400	NR	Vite TCEI bassa PG DIN 7984 CI 10.9 M 12 x 18 Z.D.Bianca	Screw DIN 7984 low PG CI 10.9 M 12 x 18 Z. D. white
BV105	BV010500	NR	Vite TE Parziale Filetto PG DIN 931 CI 8.8 M 12 x 75 Z.Bianca	Screw Partial Thread DIN 931 PG CI 8.8 M 12 x 75 Z. white
BV106	BV010600	NR	Vite TE Tutto Filetto PG DIN 933 CI 8.8 M 8 x 22 Z.Bianca	Screw All Thread DIN 933 PG CI 8.8 M 8 x 22 Z. white
BV107	BV010700	NR	Vite TE Tutto Filetto PG DIN 933 CI 8.8 M 6 x 35 Z.Bianca	Screw All Thread DIN 933 PG CI 8.8 M 6 x 35 Z. white
BV108	BV010800	NR	Vite TE Parziale Filetto PG DIN 931 CI 8.8 M 4 x 45 Z.Bianca	Screw Partial Thread DIN 931 PG CI 8.8 M 4 x 45 Z. white
BV109	BV010900	NR	Vite TE Tutto Filetto PG DIN 933 CI 10.9 M 16 x 45 Z.D.Bianca	Screw All Thread DIN 933 PG CI 10.9 M 16 x 45 ZD white
BV110	BV011000	NR	Vite TE Parziale Filetto PG DIN 931 CI 10.9 M 16 x 100	Screw Partial Thread DIN 931 PG CI 10.9 M 16 x 100
BV111	BV011100	NR	Vite TE Parziale Filetto PG DIN 931 CI 10.9 M 16 x 105	Screw Partial Thread DIN 931 PG CI 10.9 M 16 x 105
BV112	BV011200	NR	Vite TE Tutto Filetto PG DIN 933 CI 8.8 M 10 x 25 Z.Bianca	Screw All Thread DIN 933 PG CI 8.8 M 10 x 25 Z. white
BV113	BV011300	NR	Vite TSPEI PG DIN 7991 CI 10.9 M 6 x 50 Z.Bianca	TSPEI PG screw DIN 7991 CI 10.9 M 6 x 50 Z. white
BV114	BV011400	NR	Vite TSPEI PG DIN 7991 CI 10.9 M 8 x 25 Z.Bianca	TSPEI PG screw DIN 7991 CI 10.9 M 8 x 25 Z. white
BV115	BV011500	NR	Vite TE Tutto Filetto PG DIN 933 CI 8.8 M 10 x 45 Z.Bianca	Screw All Thread DIN 933 PG CI 8.8 M 10 x 45 Z. white
BV116	BV011600	NR	Vite TE Tutto Filetto PG DIN 933 CI 8.8 M 5 x 8 Z.Bianca	Screw All Thread DIN 933 PG CI 8.8 M 5 x 8 Z. white



POS	Codice	U.M.	 Descrizione	 Description
BV117	BV011700	NR	Vite TE Tutto Filetto PG DIN 933 CI 8.8 M 8 x 18 Z.Bianca	Screw All Thread DIN 933 PG CI 8.8 M 8 x 18 Z. white
BV118	BV011800	NR	Vite TE Tutto Filetto PG DIN 933 CI 8.8 M 8 x 40 Z.Bianca	Screw All Thread DIN 933 PG CI 8.8 M 8 x 40 Z. white
BV119	BV011900	NR	Vite TCEI PG DIN 912 CI 8.8 M 8 x 100 Z.Bianca	Screw DIN 912 PG CI 8.8 M 8 x 100 Z. white
BV120	BV012000	NR	Vite TCEI PG DIN 912 CI 8.8 M 8 x 110 Z.Bianca	Screw DIN 912 PG CI 8.8 M 8 x 110 Z. white
BV121	BV012100	NR	Vite TE Parziale Filetto PG DIN 931 CI 8.8 M 5 x 75 Z.Bianca	Screw Partial Thread DIN 931 PG CI 8.8 M 5 x 75 Z. white
BV122	BV012200	NR	Vite TE Parziale Filetto PG DIN 931 CI 8.8 M 12 x 130 Z.Bianca	Screw Partial Thread DIN 931 PG CI 8.8 M 12 x 130 Z. white
BV123	BV012300	NR	Vite TC Croce PG DIN 7985 CI 4.8 M 4 x 8 Z.Bianca	Cross head screw DIN 7985 PG CI 4.8 M 4 x 8 Z. white
BV124	BV012400	NR	Vite TCEI PG DIN 912 CI 8.8 M 6 x 40 Z.Bianca	Screw DIN 912 PG CI 8.8 M 6 x 40 Z. white
BV125	BV012500	NR	Vite TE Tutto Filetto PG DIN 933 CI 8.8 M 4 x 20 Z.Bianca	Screw All Thread DIN 933 PG CI 8.8 M 4 x 20 Z. white
BV126	BV012600	NR	Vite TE UNC ANSI B18.2.1 GR.5 3/8 x 1" Z.Bianca	Screw UNC ANSI B18.2.1 GR.5 3/8 x 1 "Z. White
BV127	BV012700	NR	Vite TE UNC ANSI B18.2.1 GR.5 3/8 x 1" 1/4Z.Bianca	Screw UNC ANSI B18.2.1 GR.5 3/8 x 1 "1/4 Z. White
BV128	BV012800	NR	Vite TE Tutto Filetto PG DIN 933 CI 8.8 M 4 x 16 Z.Bianca	Screw All Thread DIN 933 PG CI 8.8 M 4 x 16 Z. white
BV129	BV012900	NR	Vite TCEI PG DIN 912 CI 8.8 M 5 x 16 Z.Bianca	Screw DIN 912 PG CI 8.8 M 5 x 16 Z. white
BV130	BV013000	NR	Vite TCEI PG DIN 912 CI 8.8 M 3 x 12 Z.Bianca	Screw DIN 912 PG CI 8.8 M 3 x 12 Z. white
BV131	BV013100	NR	Vite TSPEI PG DIN 7991 CI 10.9 M 5 x 30 Z.Bianca	TSPEI PG screw DIN 7991 CI 10.9 M 5 x 30 Z. white
BV132	BV013200	NR	Vite TSPEI PG DIN 7991 CI 10.9 M 5 x 55 Z.Bianca	TSPEI PG screw DIN 7991 CI 10.9 M 5 x 55 Z. white
BV133	BV013300	NR	Vite TE Tutto Filetto PG DIN 933 CI 8.8 M 3 x 25 Z.Bianca	Screw All Thread DIN 933 PG CI 8.8 M 3 x 25 Z. white



POS	Codice	U.M.	 Descrizione	 Description
BV134	BV013400	NR	Vite TE Parziale Filetto PG DIN 931 CI 8.8 M 10 x 65 Z.Bianca	Screw Partial Thread DIN 931 PG CI 8.8 M 10 x 65 Z. white
BV135	BV013500	NR	Vite TCEI PG DIN 912 CI 8.8 M 12 x 50	Screw DIN 912 CI 9.8 M 12 x 50
BV136	BV013600	NR	Vite TSPEI PG DIN 7991 CI 10.9 M 5 x 25 Z.Bianca	TSPEI PG screw DIN 7991 CI 10.9 M 5 x 25 Z. white
BV137	BV013700	NR	Vite TCEI PG DIN 912 CI 8.8 M 8 x 30	Screw DIN 912 CI 8.8 M 8 x 30
BV138	BV013800	NR	Vite TC Croce PG DIN 7985 CI 4.8 M 5 x 10 Z.Bianca	Screw DIN 7985 CI 4.8 M 5 x 10
BV139	BV013900	NR	Vite TCEI PG DIN 912 CI 8.8 M 4 x 25 Z. Bianca	Screw DIN 912 CI 8.8 M 4 x 25 Z. Withe
BV140	BV014000	NR	Vite TE Parziale Filetto PG DIN 931 CI 8.8 M 5 x 70 Z.Bianca	Screw Partial Thread DIN 931 PG CI 8.8 M 5 x 70 Z. white
BV141	BV014100	NR	Vite TE Parziale Filetto PG DIN 931 CI 8.8 M 12 x 90 Z.Bianca	Screw Partial Thread DIN 931 PG CI 8.8 M 12 x 90 Z. white
BV142	BV014200	NR	Vite TE Parziale Filetto PG DIN 931 CI 8.8 M 8 x 55 Z.Bianca	Screw Partial Thread DIN 931 PG CI 8.8 M 8 x 55 Z. white
BV143	BV014300	NR	Vite TSPEI PG DIN 7991 CI 10.9 M 10 x 20 Z.Bianca	TSPEI PG screw DIN 7991 CI 10.9 M 10 x 20 Z. white
BV144	BV014400	NR	Vite TE Tutto Filetto PG DIN 933 CI 8.8 M 12 x 20 Z.Bianca	Screw All Thread DIN 933 PG CI 8.8 M 12 x 20 Z. white
BV145	BV014500	NR	Vite TE Tutto Filetto PG DIN 933 CI 8.8 M 12 x 35 Z.Bianca	Screw All Thread DIN 933 PG CI 8.8 M 12 x 35 Z. white
BV146	BV014600	NR	Vite TE Tutto Filetto PF DIN 961 CI 10.9 M 10 x 1,25 x 25 Z.D.Bianco	All PF thread hex head screw DIN 961 CI 10.9 M 10 x 1,25 x 25 Z.Bianca
BV147	BV014700	NR	Vite TSPEI PARZIALE FILETTO PG DIN 7991 CI 10.9 M 12 x 90 Z.Bianca	TSPEI partial THREAD PG screw DIN 7991 CI 10.9 M12 x 90 Z. white
BV148	BV014800	NR	Vite TSPEI PG DIN 7991 CI 10.9 M 6 x 16 Z.Bianca	TSPEI PG screw DIN 7991 CI 10.9 M6 x 16 Z. white
BV149	BV014900	NR	Vite TBEI PG ISO 7380 CI 10.9 M 6 x 20 Z.Bianca	Hex socket screw ISO 7380 PG CI 10.9 M 6 x 20 Z. white
BV150	BV015000	NR	Vite TE Tutto Filetto PG DIN 933 CI 10.9 M 14 x 40 Z.Bianca	Screw All Thread DIN 933 PG CI 10.9 M 14 x 40 Z. white

POS	Codice	U.M.	 Descrizione	 Description
BV151	BV015100	NR	Vite TE Parziale Filetto PG DIN 931 CI 8.8 M 10 x 85 Z.Bianca	Screw Partial Thread DIN 931 PG CI 8.8 M 10 x 85 Z. white
BV152	BV015200	NR	Vite TE Parziale Filetto PG DIN 931 CI 8.8 M 10 x 75 Z.Bianca	Screw Partial Thread DIN 931 PG CI 8.8 M 10 x 75 Z. white
BV154	BV015400	NR	Vite TCEI PG DIN 912 CI 8.8 M 8 x 35	Screw DIN 912 CI 8.8 M 8 x 35
BV155	BV015500	NR	Vite TCEI PG DIN 912 CI 8.8 M 5 x 20 GEOMET 321A	Screw DIN 912 CI 8.8 M 5 x 20 GEOMET 321A
BV156	BV015600	NR	Vite TBEI PG ISO 7380 CI 10.9 M 6 x 25 Z.Bianca	Hex socket screw ISO 7380 PG CI 10.9 M 6 x 25 Z. white
BV157	BV015700	NR	Vite TBEI PG ISO 7380 CI 10.9 M 8 x 20 Z.Bianca	Hex socket screw ISO 7380 PG CI 10.9 M 8 x 20 Z. white
BV158	BV015800	NR	Vite TBEI PG ISO 7380 CI 10.9 M 6 x 70 Z.Bianca	Hex socket screw ISO 7380 PG CI 10.9 M 6 x 70 Z. white
BV159	BV015900	NR	Vite TBEI PG ISO 7380 CI 10.9 M 10 x 20 Z.Bianca	Hex socket screw ISO 7380 PG CI 10.9 M 10 x 20 Z. white
BV160	BV016000	NR	Vite TSPEI PG DIN 7991 CI 10.9 M 4 x 16 Z.Bianca	TSPEI PG screw DIN 7991 CI 10.9 M4 x 16 Z. white
BV162	BV016200	NR	Vite TCEI PG DIN 912 CI 12.9 M14 x 45 GEOMET 321A	Screw DIN 912 CI 12.9 M14 x 45 GEOMET 321A
BV163	BV016300	NR	Vite TCEI PG DIN 912 CI 8.8 M6 x 35	Screw DIN 912 CI 8.8 M6 x 35
BV164	BV016400	NR	Vite TCEI PG DIN 912 CI 8.8 M10 x 35	Screw DIN 912 CI 8.8 M10 x 35
BV165	BV016500	NR	Vite TE Tutto Filetto PG DIN 933 CI 8.8 M8 x 12 Z.Bianca	Screw All Thread DIN 933 PG CI 8.8 M8 x 12 Z. white
BV166	BV016600	NR	Vite TCEI PG DIN 912 CI 8.8 M4 x 20 Z. BIANCA	Screw DIN 912 CI 8.8 M4 x 20 Z. WITHE
BV167	BV016700	NR	Vite TCEI PG DIN 912 CI 8.8 M4 x 20 GEOMET 321A	All PF thread hex head screw DIN 961 CI 8.8 M 12 x 1,25 x 30 Z.Bianca
BV168	BV016800	NR	Vite TE Tutto Filetto PF DIN 961 CI 8.8 M 10 x 1,25 x 30 Z.Bianca	All PF thread hex head screw DIN 961 CI 8.8 M 10 x 1,25 x 30 Z.Bianca
BV169	BV016900	NR	Vite TCEI PG DIN 912 CI 8.8 M 10 x 1,25 x 30 ZINCATA BIANCA	Screw DIN 912 CI 8.8 M10 x 1,25 x 30

POS	Codice	U.M.	 Descrizione	 Description
BV170	BV017000	NR	Vite TE Parziale Filetto PF DIN 960 CI 8.8 M 10 x 1,25 x 60 Z.Bianca	Partial PF thread hex head screw DIN 960 CI 8.8 M 10 x 1,25 x 60 Z.Bianca
BV171	BV017100	NR	Vite TE Tutto Filetto PF DIN 961 CI 10.9 M 12 x 1,25 x 25 Z.Bianca	All PF thread hex head screw DIN 961 CI 10.9 M 12 x 1,25 x 25 Z.Bianca
BV172	BV017200	NR	Vite TE UNC ANSI B18.2.1 GR.5 5/8 passo 11 L= 1" 1/2 GEOMET 500	UNC hex head screw ANSI B18.2.1 GR.5 5/8 11 L = 1 "1/2 GEOMET 500
BV173	BV017300	NR	Vite TE Tutto Filetto PG DIN 933 CI 8.8 M12 x 30 Z.Bianca	Screw All Thread DIN 933 PG CI 8.8 M12 x 30 Z. white
BV174	BV017400	NR	Vite TE Tutto Filetto PG DIN 933 CI 8.8 M5 x 45 Z.Bianca	Screw All Thread DIN 933 PG CI 8.8 M5 x 45 Z. white
BV175	BV017500	NR	Vite TE Parziale Filetto PG DIN 931 CI 8.8 M 12 x 80 Z.Bianca	Screw Partial Thread DIN 931 PG CI 8.8 M12 x 80 Z. white
BV176	BV017600	NR	Vite TCEI PG DIN 912 CI 8.8 M 6 x 25 Z.Bianca	Screw DIN 912 CI 8.8 M6 x 25
BV177	BV017700	NR	Vite TE Parziale Filetto PG DIN 931 CI 8.8 M 12 x 85 Z.Bianca	Screw Partial Thread DIN 931 PG CI 8.8 M12 x 85 Z. white
BV178	BV017800	NR	Vite TE Tutto Filetto PG DIN 933 CI 8.8 M8 x 90 Z.Bianca	Screw All Thread DIN 933 PG CI 8.8 M8 x 90 Z. white
BV179	BV017900	NR	Vite TE Tutto Filetto PG DIN 933 CI 8.8 M5 x 40 Z.Bianca	Screw All Thread DIN 933 PG CI 8.8 M5 x 40 Z. white
BV180	BV018000	NR	Vite TE Tutto Filetto PG DIN 933 CI 8.8 M6 x 75 Z.Bianca	Screw All Thread DIN 933 PG CI 8.8 M6 x 75 Z. white
BV182	BV018200	NR	Vite TE Tutto Filetto PG DIN 933 CI 10.9 M 16 x 70 Z.Bianca	Screw All Thread DIN 933 PG CI 10.9 M 16 x 70 Z. white
BV183	BV018300	NR	Vite TE Tutto Filetto PG DIN 933 CI 8.8 M5 x 10 Z.Bianca	Screw All Thread DIN 933 PG CI 8.8 M5 x 10 Z. white
BV184	BV018400	NR	Vite TE Tutto Filetto PG DIN 933 CI 8.8 M10 x 16 Z.Bianca	Screw All Thread DIN 933 PG CI 8.8 M10 x 16 Z. white
BV185	BV018500	NR	Vite TCEI PG DIN 912 CI 8.8 M 8 x 55 Z.Bianca	Screw DIN 912 CI 8.8 M8 x 55
BV186	BV018600	NR	Vite TCEI PG DIN 912 CI 12.9 M10 x 30 GEOMET 321A	Screw DIN 912 CI 12.9 M10 x 30 GEOMET 321A
BV187	BV018700	NR	Vite TCEI PG DIN 912 CI 12.9 M14 x 40 GEOMET 321A	Screw DIN 912 CI 12.9 M14 x 40 GEOMET 321A



POS	Codice	U.M.	 Descrizione	 Description
BV188	BV018800	NR	Vite TE Tutto Filetto PG DIN 933 CI 8.8 M 12 x 60 Z.Bianca	Screw All Thread DIN 933 PG CI 8.8 M12 x 60 Z. white
BV189	BV018900	NR	Vite TE Tutto Filetto PG DIN 933 CI 8.8 M 12 x 55 Z.Bianca	Screw All Thread DIN 933 PG CI 8.8 M12 x 55 Z. white
BV190	BV019000	NR	Vite TE Tutto Filetto PG DIN 933 CI 8.8 M 12 x 50 Z.Bianca	Screw All Thread DIN 933 PG CI 8.8 M12 x 50 Z. white
BV191	BV019100	NR	Vite TE Tutto Filetto PG DIN 933 CI 8.8 M 16 x 50 Z.Bianca	Screw All Thread DIN 933 PG CI 8.8 M16 x 50 Z. white
BV192	BV019200	NR	Vite TE Tutto Filetto PG DIN 933 CI 8.8 M 16 x 55 Z.Bianca	Screw All Thread DIN 933 PG CI 8.8 M16 x 55 Z. white
BV193	BV019300	NR	Vite TE Parziale Filetto PG DIN 931 CI 8.8 M 10 x 55 Z.Bianca	Screw Partial Thread DIN 931 PG CI 8.8 M 10 x 55 Z. white
BV194	BV019400	NR	Vite TE Parziale Filetto PG DIN 931 CI 8.8 M 16 x 230 Z.Bianca	Screw Partial Thread DIN 931 PG CI 8.8 M 16 x 230 Z. white
BV195	BV019500	NR	Vite TE Parziale Filetto PG DIN 931 CI 8.8 M 6 x 50 Z.Bianca	Screw Partial Thread DIN 931 PG CI 8.8 M 6 x 50 Z. white
BV196	BV019600	NR	Vite TE Parziale Filetto PG DIN 931 CI 8.8 M 6 x 65 Z.Bianca	Screw Partial Thread DIN 931 PG CI 8.8 M 6 x 65 Z. white
BV197	BV019700	NR	Vite TE Parziale Filetto PG DIN 931 CI 8.8 M 8 x 45 Z.Bianca	Screw Partial Thread DIN 931 PG CI 8.8 M 8 x 45 Z. white
BV198	BV019800	NR	Vite TE Parziale Filetto PG DIN 931 CI 8.8 M 8 x 55 Z.Bianca	Screw Partial Thread DIN 931 PG CI 8.8 M 8 x 55 Z. white
BV199	BV019900	NR	Vite TE Parziale Filetto PG DIN 931 CI 8.8 M 8 x 60 Z.Bianca	Screw Partial Thread DIN 931 PG CI 8.8 M 8 x 60 Z. white
BV200	BV020000	NR	Vite TE Tutto Filetto PG DIN 933 CI 10.9 M 16 x 40	Screw All Thread DIN 933 PG CI 10.9 M 16 x 40
BV201	BV020100	NR	Vite TSPEI PG DIN 7991 CI 10.9 M16 x 45 Z.Bianca	TSPEI PG screw DIN 7991 CI 10.9 M16 x 45 Z. white
BV202	BV020200	NR	Vite TCEI PG DIN 912 CI 12.9 M3 x 12 ZINC. iridescente Fe/Zn5IVs	Screw DIN 912 CI 12.9 M3 x 12 ZINC. iridescente Fe/Zn5IVs
BV203	BV020300	NR	Vite TC Croce PG DIN 7985 CI 4.8 M M 3 x 5 Z.Bianca	Screw DIN 7985 CI 4.8 M M 3 x 5
BV204	BV020400	NR	Vite TC Croce PG DIN 7985 CI 4.8 M M 3 x 8 Z.Bianca	Screw DIN 7985 CI 4.8 M M 3 x 8



POS	Codice	U.M.	 Descrizione	 Description
BV205	BV020500	NR	Vite TTQST DIN 603/555 CI 4.8 M 8 x 35 Z.Bianca	TTQST Screw DIN 603/555 CL 4.8 M 8 x 35 Z. White
BV206	BV020600	NR	Vite TC Croce PG DIN 7985 CI 4.8 M M 5 x 80 Z.Bianca	Screw DIN 7985 CI 4.8 M M 5 x 80
BV207	BV020700	NR	Vite TE Parziale Filetto PG DIN 931 CI 8.8 M 10 x 80 Z.Bianca	Screw Partial Thread DIN 931 PG CI 8.8 M 10 x 80 Z. white
BV208	BV020800	NR	Vite TE Tutto Filetto PG DIN 933 CI 8.8 M 16 x 35 Z.D.Bianca	Screw All Thread DIN 933 PG CI 8.8 M 16 x 35 ZD white
BV209	BV020900	NR	Vite TE Parziale Filetto PG DIN 931 CI 8.8 M 10 x 95 Z.Bianca	Screw Partial Thread DIN 931 PG CI 8.8 M 10 x 95 Z. white
BV210	BV021000	NR	Vite TE Tutto Filetto PG DIN 933 CI 8.8 M 6 x 14 Z.D.Bianca	Screw All Thread DIN 933 PG CI 8.8 M 6 x 14 ZD white
BV211	BV021100	NR	Vite TE Tutto Filetto PG DIN 933 CI 8.8 M 12 x 25 Z.D.Bianca	Screw All Thread DIN 933 PG CI 8.8 M 12 x 25 ZD white
BV212	BV021200	NR	Vite TE Tutto Filetto PG DIN 933 CI 8.8 M 4 x 14 Z.D.Bianca	Screw All Thread DIN 933 PG CI 8.8 M 4 x 14 ZD white
BV213	BV021300	NR	Vite TE Tutto Filetto PG DIN 933 CI 10.9 M 16 x 60	Screw All Thread DIN 933 PG CI 10.9 M 16 x 60
BV214	BV021400	NR	Vite TE Parziale Filetto PG DIN 931 CI 8.8 M 6 x 100 Z.Bianca	Screw Partial Thread DIN 931 PG CI 8.8 M 6 x 100 Z. white
BV215	BV021500	NR	Vite TE Parziale Filetto PG DIN 931 CI 10.9 M 16 x 110	Screw Partial Thread DIN 931 PG CI 10.9 M 16 x 110
BV216	BV021600	NR	Vite TE Parziale Filetto PG DIN 931 CI 10.9 M 16 x 240 Z.D.Bianca	Screw Partial Thread DIN 931 PG CI 10.9 M 16 x 240 ZD white
BV217	BV021700	NR	Vite TSPEI PG DIN 7991 CI 10.9 M 8 x 30 Z.Bianca	TSPEI PG screw DIN 7991 CI 10.9 M8 x 30 Z. white
BV218	BV021800	NR	Vite TSPEI PG DIN 7991 CI 10.9 M 5 x 6 Z.Bianca	TSPEI PG screw DIN 7991 CI 10.9 M5 x 6 Z. white
BV219	BV021900	NR	Vite TSPEI PG DIN 7991 CI 10.9 M 5 x 70 Z.Bianca	TSPEI PG screw DIN 7991 CI 10.9 M5 x 70 Z. white
BV220	BV022000	NR	Vite TSPEI PG DIN 7991 CI 10.9 M 12 x 35 Z.Bianca	TSPEI PG screw DIN 7991 CI 10.9 M12 x 35 Z. white
BV221	BV022100	NR	Vite TCEI PG DIN 912 CI 12.9 M10 x 20 GEOMET 321A	Screw DIN 912 CI 12.9 M10 x 20 GEOMET 321A



POS	Codice	U.M.	 Descrizione	 Description
BV222	BV022200	NR	Vite TCEI PG DIN 912 CI 12.9 M8 x 90 GEOMET 321A	Screw DIN 912 CI 12.9 M8 x 90 GEOMET 321A
BV223	BV022300	NR	Vite TCEI PG DIN 912 CI 12.9 M3 x 5 ZINC.	Screw DIN 912 CI 12.9 M3 x 5 ZINC.
BV224	BV022400	NR	Vite TBEI PG ISO 7380 CI 10.9 M 8 x 22 Z.Bianca	Hex socket screw ISO 7380 PG CI 10.9 M 8 x 22 Z. white
BV225	BV022500	NR	Vite TE Parziale Filetto PG DIN 931 CI 8.8 M 10 x 100 Z.Bianca	Screw Partial Thread DIN 931 PG CI 8.8 M 10 x 100 Z. white
BV226	BV022600	NR	Vite TE Parziale Filetto PG DIN 931 CI 8.8 M 10 x 110 Z.Bianca	Screw Partial Thread DIN 931 PG CI 8.8 M 10 x 110 Z. white
BV227	BV022700	NR	Vite TE parziale Filetto PG DIN 931 CI 10.9 M 12 x 45 Z.D.Bianca	Screw partial Thread DIN 931 PG CI 10.9 M 12 x 45 ZD white
BV228	BV022800	NR	Vite TE Tutto Filetto PG DIN 933 CI 10.9 M 14 x 35 Z.D.Bianca	Screw All Thread DIN 933 PG CI 10.9 M 14 x 35 ZD white
BV229	BV022900	NR	Vite TSPEI PG DIN 7991 CI 10.9 M 12 x 30 Z.Bianca	TSPEI PG screw DIN 7991 CI 10.9 M12 x 30 Z. white
BV230	BV023000	NR	Vite TE flangiata Tutto Filetto PG DIN 6921 CI 8.8 M 5 x 12 Zinconickel nero +sigillante	Flange Screw All Thread DIN 6921 PG CI 8.8 M 5 x 12 Zinconickel black +sealant
BV231	BV023100	NR	Vite TE flangiata Tutto Filetto PG DIN 6921 CI 8.8 M 6 x 16 Zinconickel nero +sigillante	Flange Screw All Thread DIN 6921 PG CI 8.8 M 6 x 16 Zinconickel black +sealant
BV232	BV023200	NR	Vite TE Tutto Filetto PG DIN 933 CI 8.8 M 5 x 25 Z.D.Bianca	Screw All Thread DIN 933 PG CI 8.8 M 5 x 25 ZD white
BV233	BV023300	NR	Vite TE Tutto Filetto PG DIN 933 CI 8.8 M 8 x 130 Z.D.Bianca	Screw All Thread DIN 933 PG CI 8.8 M 8 x 130 ZD white
BV234	BV023400	NR	Vite TBEI PG ISO 7380 CI 10.9 M 10 X 30 Z.Bianca	Hex socket screw ISO 7380 PG CI 10.9 M 10 X 30 Z. white
BV235	BV023500	NR	Vite TE Tutto Filetto PG DIN 933 CI 10.9 M 16 x 35 Z.D.Bianca	Screw All Thread DIN 933 PG CI 10.9 M 16 x 35 ZD white
BV236	BV023600	NR	Vite TE Parziale Filetto PG DIN 931 CI 8.8 M 6 x 45 Z.Bianca	Screw Partial Thread DIN 931 PG CI 8.8 M 6 x 45 Z. white
BV237	BV023700	NR	Vite TE Tutto Filetto PG DIN 933 CI 10.9 M 12 x 30 Z.D.Bianca	Screw All Thread DIN 933 PG CI 10.9 M 12 x 30 ZD white



POS	Codice	U.M.	 Descrizione	 Description
BV238	BV023800	NR	Vite TE Parziale Filetto PG DIN 931 CI 8.8 M 16 x 90 Z.Bianca	Screw Partial Thread DIN 931 PG CI 8.8 M 16 x 90 Z. white
BV239	BV023900	NR	Vite TE Parziale Filetto PG DIN 931 CI 8.8 M 12 x 65 Z.Bianca	Screw Partial Thread DIN 931 PG CI 8.8 M 12 x 65 Z. white
BV240	BV024000	NR	Vite TC Croce PG DIN 7985 CI 4.8 M 5 x 20 Z.Bianca	Screw DIN 7985 CI 4.8 M 5 x 20
BV241	BV024100	NR	Vite TSPEI PG DIN 7991 CI 10.9 M 10 x 35 Z.Bianca	TSPEI PG screw DIN 7991 CI 10.9 M 10 x 35 Z. white
BV242	BV024200	NR	Vite TSPEI PG DIN 7991 CI 10.9 M 6 x 12 Z.Bianca	TSPEI PG screw DIN 7991 CI 10.9 M 6 x 12 Z. white
BV243	BV024300	NR	Vite TE Parziale Filetto PG DIN 931 CI 8.8 M 12 x 150 Z.Bianca	Screw Partial Thread DIN 931 PG CI 8.8 M 12 x 150 Z. white
BV244	BV024400	NR	Vite TCEI PG DIN 912 CI 8.8 M5 x 50 ZINGATA BIANCA	Screw DIN 912 CI 8.8 M5 x 50
BV245	BV024500	NR	Vite TE Parziale Filetto PG DIN 931 CI 8.8 M 8 x 110 Z.Bianca	Screw Partial Thread DIN 931 PG CI 8.8 M 8 x 110 Z. white
BV246	BV024600	NR	Vite TE Parziale Filetto PG DIN 931 CI 8.8 M 8 x 40 Z.Bianca	Screw Partial Thread DIN 931 PG CI 8.8 M 8 x 40 Z. white
BV247	BV024700	NR	Vite TE Tutto Filetto PG DIN 933 CI 8.8 M 5 x 50 Z.D.Bianca	Screw All Thread DIN 933 PG CI 8.8 M 5 x 50 ZD white
BV248	BV024800	NR	Vite TCEI PG DIN 912 CI 8.8 M5 x 18 Z. BIANCA	Screw DIN 912 CI 8.8 M5 x 18 Z. WITHE
BV249	BV024900	NR	Vite TSPEI PG DIN 7991 CI 10.9 M 5 x 65 Z.Bianca	TSPEI PG screw DIN 7991 CI 10.9 M 5 x 65 Z. white
BV251	BV025100	NR	Vite TSPEI PG DIN 7991 CI 10.9 M 8 x 35 Z.Bianca	TSPEI PG screw DIN 7991 CI 10.9 M 8 x 35 Z. white
BV252	BV025200	NR	Vite TE Tutto Filetto PG DIN 933 CI 10.9 M 12 x 40 Z.D.Bianca	Screw All Thread DIN 933 PG CI 10.9 M 12 x 40 ZD white
BV253	BV025300	NR	Vite TBEI PG ISO 7380 M 6 x 55 Z.Bianca	Hex socket screw ISO 7380 PG M 6 x 55 Z. white
BV254	BV025400	NR	Vite TE Tutto Filetto PG DIN 933 CI 10.9 M 10 x 35 Z.D.Bianca	Screw All Thread DIN 933 PG CI 10.9 M 10 x 35 ZD white

POS	Codice	U.M.	 Descrizione	 Description
BV255	BV025500	NR	Vite TE Tutto Filetto PG DIN 933 CI 12.9 M 14 x 55 Z.D.Bianca	Screw All Thread DIN 933 PG CI 12.9 M 14 x 55 ZD white
BV256	BV025600	NR	Vite Testa Svasata Croce Autofilettante 6 x25	Screw Head Cross Countersunk Self Tapping 6 x 25
BV257	BV025700	NR	Vite TE Tutto Filetto PG DIN 933 CI 8.8 M14 x 30 Z.Bianca	Screw All Thread DIN 933 PG CI 8.8 M14 x 30 Z. white
BV258	BV025800	NR	Vite TE Tutto Filetto PG DIN 933 CI 10.9 M 12 x 35 Z.D.Bianca	Screw All Thread DIN 933 PG CI 10.9 M 12 x 35 ZD white
BV259	BV025900	NR	Vite TE Tutto Filetto PG DIN 933 CI 8.8 M 16 x 45 Z.Bianca	Screw All Thread DIN 933 PG CI 8.8 M16 x 45 Z. white
BV260	BV026000	NR	Vite TCEI PG DIN 912 CI 10.9 M 12 x 30 ZINCATA BIANCA	Screw DIN 912 CI 10.9 M 12 x 30
BV261	BV026100	NR	Vite TCEI PG DIN 912 CI 10.9 M 12 x 20 ZINCATA BIANCA	Screw DIN 912 CI 10.9 M 12 x 20
BV262	BV026200	NR	Vite TCEI PG DIN 912 CI 12.9 M14 x 35 GEOMET 321A	Screw DIN 912 CI 12.9 M14 x 35 GEOMET 321A
BV263	BV026300	NR	Vite TCEI PG DIN 912 CI 12.9 M14 x 3 GEOMET 321A	Screw DIN 912 CI 12.9 M14 x 3 GEOMET 321A
BV264	BV026400	NR	Vite TSPEI PG DIN 7991 CI 10.9 M 12 x 25 Z.Bianca	TSPEI PG screw DIN 7991 CI 10.9 M12 x 25 Z. white
BV265	BV026500	NR	Vite TE Parziale Filetto PG DIN 931 CI 10.9 M 16 x 180 GEOMET 321A	Screw Partial Thread DIN 931 PG CI 10.9 M 16 x 180 GEOMET 321A
BV266	BV026600	NR	Vite TE Tutto Filetto PG DIN 933 CI 8.8 M8 x 10 Z.Bianca	Screw All Thread DIN 933 PG CI 8.8 M8 x 10 Z. white
BV267	BV026700	NR	Vite TCEI PG DIN 912 CI 8.8 M 12 x 40	Screw DIN 912 CI 9.8 M 12 x 40
BV268	BV026800	NR	Vite TE Parziale Filetto PG DIN 931 CI 8.8 M 12 x 140 Z.Bianca	Screw Partial Thread DIN 931 PG CI 8.8 M 12 x 140 Z. white
BV269	BV026900	NR	Vite TC Croce PG DIN 7985 CI 4.8 M 6 x 25 Z.Bianca	Screw DIN 7985 CI 4.8 M 6 x 25
BV270	BV027000	NR	Vite TCEI PG DIN 912 CI 8.8 M 12 x 40	Screw DIN 912 CI 9.8 M 12 x 40
BV271	BV027100	NR	TCEI UNC ASME/ANSI B18.3 ASTM A 574 1/2 x 1"1/4 GEOMET	TCEI UNC ASME/ANSI B18.3 ASTM A 574 1/2 x 1"1/4 GEOMET

POS	Codice	U.M.	 Descrizione	 Description
BV272	BV027200	NR	TCEI UNC ASME/ANSI B18.3 ASTM A 574 1/4-20 x 1"1/2 GEOMET	TCEI UNC ASME/ANSI B18.3 ASTM A 574 1/4-20 x 1"1/2 GEOMET
BV273	BV027300	NR	Vite TE Parziale Filetto PG DIN 931 CI 8.8 M 12 x 70 Z.Bianca	Screw Partial Thread DIN 931 PG CI 8.8 M 12 x 70 Z. white
BV274	BV027400	NR	Vite TE Tutto Filetto PG DIN 933 CI 8.8 M 5 x 20 Z.D.Bianca	Screw All Thread DIN 933 PG CI 8.8 M 5 x 20 ZD white
BV275	BV027500	NR	Vite TSPEI PG DIN 7991 CI 10.9 M 6 x 70 Z.Bianca	TSPEI PG screw DIN 7991 CI 10.9 M 6 x 70 Z. white
BV276	BV027600	NR	Vite TCEI PG DIN 912 CI 8.8 M 5 x 14 Z.Bianca	Screw DIN 912 PG CI 8.8 M 5 x 14 Z. white
BV277	BV027700	NR	Vite TBEI PG ISO 7380 CI 10.9 M 10 x 35 Z.Bianca	Hex socket screw ISO 7380 PG CI 10.9 M 10 x 35 Z. white
BV281	BV028100	NR	Vite TE Parziale Filetto PG DIN 931 CI 8.8 M 14 x 45 Z.Bianca	Screw Partial Thread DIN 931 PG CI 8.8 M 14 x 45 Z. white



POS	Codice	U.M.	 Descrizione	 Description
RB1	RB000100	NR	DADO PER OGIVA Ø=12	NUT FOR OGIVA Ø = 12
RD1	RD000100	NR	RACCORDO CORPO A "T" EO F(DKOL)-M-M 8L	FITTING BODY A "T" EO F (DKOL) M-M-8L
RD2	RD000200	NR	RACCORDO CORPO A "T" EO F(DKOL)-M-M 10L	FITTING BODY A "T" EO F (DKOL) M-M-10L
RD3	RD000300	NR	RACCORDO CORPO A "T" EO F(DKOL)-M-M 12L	FITTING BODY A "T" EO F (DKOL) M-M-12L
RD4	RD000400	NR	RACCORDO CORPO A "T" EO F(DKOL)-M-M 15L	FITTING BODY A "T" EO F (DKOL) M-M-15L
RD5	RD000500	NR	RACCORDO CORPO A "T" EO M-F(DKOL)-M 10L	FITTING BODY A "T" EO M-F (DKOL) M-10L
RD6	RD000600	NR	RACCORDO CORPO A "T" EO M-F(DKOL)-M 12L	FITTING BODY A "T" EO M-F (DKOL) M-12L
RD7	RD000700	NR	RACCORDO CORPO A "T" EO 8L M 14*1.5	FITTING BODY A "T" EO 8L M 14 * 1.5
RD8	RD000800	NR	RACCORDO CORPO A "T" EO 10L M 16*1.5	FITTING BODY A "T" M 10L EO 16 * 1.5
RD9	RD000900	NR	RACCORDO CORPO A "T" EO 28L M 36*2	FITTING BODY A "T" M 28L EO 36 * 2
RD10	RD001000	NR	RACCORDO CORPO A "T" EO 28L M 36*2	FITTING BODY A "T" EO M-F (DKOL) M-10L
RD11	RD001100	NR	RACCORDO CORPO A "T" EO M-F(DKOL)-M 10L	FITTING BODY A "T" EO M-F (DKOL) M-10L
RD12	RD001200	NR	ADATTATORE "T" GAS M-FG-M 1/4 1/4 1/4	ADAPTOR
RG1	RG000100	NR	RACCORDO CORPO A GOMITO 10L MASCH.-FEMM. DKOL	ELBOW FITTING BODY 10L Masch.-FEMM. DKOL
RG2	RG000200	NR	RACCORDO CORPO A GOMITO 12L MASCH.-FEMM. DKOL	ELBOW FITTING BODY 12L Masch.-FEMM. DKOL
RG3	RG000300	NR	RACCORDO CORPO A GOMITO 20S MASCHIO-FEMMINA DKOS	20S BODY FITTING ELBOW MALE-FEMALE DKOS
RG4	RG000400	NR	RACCORDO CORPO A GOMITO 28L MASCHIO-FEMMINA DKOL	28L BODY FITTING ELBOW MALE-FEMALE DKOL

POS	Codice	U.M.	 Descrizione	 Description
RG5	RG000500	NR	RACCORDO A L MASCHIO-FEMMINA 1/8	BODY 90 ° M / F 1/8 "
RG6	RG000600	NR	ADATTATORE 90° BSPP M-FG 1/4	ADAPTOR
RN1	RN000100	NR	RACCORDO CORPO D'ESTREMITA' TENUTA ED 8L * 3/8 GAS *K*	END FITTING WITH SEAL ED 8L * 3/8 GAS * K *
RN2	RN000200	NR	RACCORDO CORPO D'ESTREMITA' TENUTA ED 12L * 3/8 GAS *K*	END FITTING WITH SEAL ED 12L * 3/8 GAS * K *
RN3	RN000300	NR	RACCORDO CORPO D'ESTREMITA' TENUTA ED 10L * 3/8 GAS *K*	FITTING END OF BODY 'AND SEAL 10L * 3/8 GAS * K *
RN4	RN000400	NR	RACCORDO CORPO D'ESTREMITA' TENUTA ED 8L * 1/4 GAS *K*	END FITTING WITH SEAL ED 8L * 1/4 GAS * K *
RN5	RN000500	NR	RACCORDO CORPO D'ESTREMITA'TENUTA ED 10L * 1/4 GAS *K*	FITTING END OF BODY 'AND SEAL 10L * 1/4 GAS * K *
RN6	RN000600	NR	RACCORDO CORPO D'ESTREMITA' TENUTA ED 12L * 1/4 GAS	FITTING END OF BODY 'AND SEAL 12L * 1/4 GAS
RN7	RN000700	NR	RACCORDO NIPLES GAS CON.- GAS CON. 1/4" * 1/4"	FITTING
RN8	RN000800	NR	RACCORDO CORPO D'ESTREMITA' TENUTA ED 15L * 1/2 GAS *K*	END FITTING WITH SEAL ED 15L * 1/2 * K * GAS
RN9	RN000900	NR	RACCORDO CORPO D'ESTREMITA' TENUTA ED 10L * 1/2 GAS *K*	FITTING END OF BODY 'AND SEAL 10L * 1/2 * K * GAS
RN10	RN001000	NR	RACCORDO CORPO D'ESTREMITA' TENUTA ED 15L * 3/4 GAS *K*	END FITTING WITH SEAL ED 15L * 3/4 GAS * K *
RN11	RN001100	NR	RACCORDO CORPO D'ESTREMITA' TENUTA ED 12L * 1/2 GAS *K*	END FITTING WITH SEAL ED 12L * 1/2 GAS * K *
RN12	RN001200	NR	RACCORDO CORPO D'ESTR. TENUTA ED 8L * 1/2 GAS	END FITTING WITH SEAL ED 8L * 1/2 GAS
RN13	RN001300	NR	RACCORDO CORPO D'ESTR. TENUTA ED 8L * 3/4 GAS	CONNECTOR BODY OF EXTR. SEAL AND 8L * 3/4 GAS
RN14	RN001400	NR	RACCORDO CORPO D'ESTR. TENUTA ED 12L * 3/4 GAS	CONNECTOR BODY OF EXTR. SEAL AND 12L * 3/4 GAS

POS	Codice	U.M.	 Descrizione	 Description
RN15	RN001500	NR	RACCORDO CORPO D'ESTR.TENUTA ED 15L * 3/8 GAS	END FITTING WITH SEAL ED 15L * 3/8 GAS
RN16	RN001600	NR	RACCORDO CORPO D'ESTR.TENUTA ED 22L * 3/4 GAS	END FITTING WITH SEAL ED 22L * 3/4 GAS
RN17	RN001700	NR	RACCORDO CORPO D'ESTR. TENUTA ED 28L * 3/4" GAS	END FITTING WITH SEAL ED 28L * 3/4 BSP
RN18	RN001800	NR	RACCORDO CORPO D'ESTR. TENUTA ED 20S * 3/4 GAS	CONNECTOR BODY OF EXTR. SEAL AND 20S * 3/4 GAS
RN19	RN001900	NR	RACCORDO CORPO D'ESTREMITA' 8L * M 12X1.5 ED	END FITTING 8L * M 12x1.5 ED
RN20	RN002000	NR	RACCORDO CORPO D'ESTREMITA' 8L * M 14X1.5 ED	FITTING END OF BODY 'AND 8L * M 14x1.5
RN21	RN002100	NR	RACCORDO CORPO D'ESTREMITA' 10L * M 18X1.5 ED	END FITTING 10L * M 18x1.5
RN22	RN002200	NR	RACCORDO CORPO D'ESTR. TENUTA ED 15L * M 18X1.5	CONNECTOR BODY OF EXTR. SEAL AND 15L * M 18x1.5
RN23	RN002300	NR	RACCORDO CORPO D'ESTR. TENUTA ED 15L * M 22X1.5	END FITTING WIHT SEAL ED 15L * M 22x1.5
RN24	RN002400	NR	RACCORDO CORPO D'ESTR. TENUTA ED 22L * M26X1.5	CONNECTOR BODY OF EXTR. SEAL AND 22L * M26x1.5
RN25	RN002500	NR	RACCORDO CORPO D'ESTR. TENUTA ED 20S * M27X2	CONNECTOR BODY OF EXTR. SEAL AND 20S * M27X2
RN26	RN002600	NR	RACCORDO CORPO D'ESTR. 8L * 9/16-18 UNF-2A	END FITTING 8L * 9/16-18 UNF-2A
RN27	RN002700	NR	RACCORDO CORPO D'ESTR. 12L * 3/4 -16 UNF-2A	END FITTING 12L * 3/4 -16 UNF-2A
RN28	RN002800	NR	RACCORDO CORPO D'ESTR. 20S * 1.5/16 -12 UN-2A	END FITTING 20S * 1.5/16 -12 UN-2A
RN29	RN002900	NR	RACCORDO CORPO D'ESTR. TENUTA ED 22L * M26X1.5	END FITTING WITH SEAL ED 22L * M26x1.5
RN30	RN003000	NR	RACCORDO CORPO D'ESTR. TENUTA ED 22L * M26X1.5	END FITTING WITH SEAL ED 22L * M26x1.5
RN31	RN003100	NR	RACCORDO CORPO D'ESTREMITA' TENUTA ED 6L * 1/4 GAS *K*	END FITTING WITH SEAL 1/4 BSPP 6L

POS	Codice	U.M.	 Descrizione	 Description
RN32	RN003200	NR	RACCORDO CORPO D'ESTREMITA' TENUTA ED 8L * 3/8 GAS *K*	END FITTING WITH SEAL ED 8L * 3/8 GAS * K *
RN33	RN003300	NR	NIPPLES 1/8" JIS 1/8"GAS	CAP
RN34	RN003400	NR	NIPPLES 1/4" JIS 1/4"GAS	CAP
RN35	RN003500	NR	NIPPLES 3/8" JIS 1/4"GAS	CAP
RN36	RN003600	NR	NIPPLES 3/8" JIS 1/4"GAS	CAP
RO1	RO000100	NR	OGIVA PER TUBO Ø=12	OGIVE FOR TUBE Ø = 12
RR1	RR000100	NR	RONDELLA RAME 1/4	COPPER WASHER 1/4
RR2	RR000200	NR	RONDELLA BONDED GAS 3/8" *K*	BONDED WASHER GAS 3/8 " * K *
RR3	RR000300	NR	RONDELLA BONDED METRICA 12 *K*	METRIC BONDED WASHER 12 * K *
RR4	RR000400	NR	RONDELLA BONDED GAS 1/4" *K*	BONDED WASHER GAS 1/4 " * K *
RR5	RR000500	NR	RONDELLA BONDED GAS 1/2" *K*	BONDED WASHER GAS 1/2 " * K *
RR6	RR000600	NR	RONDELLA RAME 3/8	COPPER WASHER 3/8
RR7	RR000700	NR	RONDELLA BONDED GAS 1/8" *K*	BONDED WASHER GAS 1/8 " * K *
RR8	RR000800	NR	RONDELLA BONDED GAS 1" *K*	BONDED WASHER GAS 1 " * K *
RR9	RR000900	NR	RONDELLA BONDED GAS 3/4" *K*	BONDED WASHER GAS 3/4 " * K *
RR10	RR001000	NR	RONDELLA BONDED GAS 1.1/4"	BONDED WASHER GAS 1.1 / 4 "
RR11	RR001100	NR	RONDELLA RAME M10	COPPER WASHER M10
RR12	RR001200	NR	RONDELLA RAME 1/2	COPPER WASHER 1/2

POS	Codice	U.M.	 Descrizione	 Description
RR13	RR001300	NR	RONDELLA BONDED M12	BONDED WASHER M12
RS1	RS000100	NR	COPPIA SEMIFLANGE SAE 6000 3/4"	PAIR 6000 SAE flange halves 3/4 "
RS2	RS000200	NR	RACC.M 20S(M30x2) - ED M 1"5/16 UNF H=33	FITTING M 20S (M30x2) - ED M 1 "5/16 UNF H = 33
RS3	RS000300	NR	RIDUZIONE M-F GAS 1" * 1/2"	REDUCING GAS M-F 1 "*" 1/2"
RS4	RS000400	NR	RACCORDO COLONNETTA M15L - 3/8" GAS H=50	COLUMN CONNECTION M15L - 3/8 "GAS H = 50
RS5	RS000500	NR	RACCORDO COLONNETTA M15L - 3/8" GAS H=96	COLUMN CONNECTION M15L - 3/8 "GAS H = 96
RS6	RS000600	NR	CODOLO M1/4" ED X FG 8L (M14X1.5)	FITTING M1 / 4 "X AND FG 8L (M14X1.5)
RS7	RS000700	NR	RIDUZIONE M-F GAS 1" * 1/2"	REDUCING GAS M-F 1 "*" 1/2"
RS8	RS000800	NR	RACCORDO CODOLO D' ESTR. FEM. DKO 12I*3/8 GAS ED	END FITTING FEM. DKO 12I*3/8 GAS ED
RS9	RS000900	NR	MANICOTTO ARIA 1/8-1/8	AIR MANIFOLD 1/8-1/8
RS10	RS001000	NR	RIDUZIONE M-F GAS 3/8" JIS 1/8" BSPP	REDUCING GAS M-F 3/8" JIS 1/8" BSPP
RS11	RS001100	NR	RACCORDO M-M 15L	FITTING M-M 15L
RS12	RS001200	NR	RACCORDO NIPLES GAS CON.- GAS CON.1/2"1/2"	FITTING 1/2" - 1/2"
RT1	RT000100	NR	TAPPO MASCHIO TE GAS 3/8" SVASATO 60° *K*	SCREW EYE FOR GAS 1/2 "H = 50
RT2	RT000200	NR	TAPPO MASCHIO ESAGONO INTERNO GAS 1/4" SVASATO 60° *K*	MALE PLUG GAS INTERNAL HEX 1/4 "FLARE 60 ° * K *
RT3	RT000300	NR	TAPPO MASCHIO TE GAS 1/2" SVASATO 60° *K*	MALE PLUG TE GAS 1/2 "FLARE 60 ° * K *
RT4	RT000400	NR	TAPPO MASCHIO TE GAS 1/4" SVASATO 60° *K*	MALE PLUG TE GAS 1/4 "FLARE 60 ° * K *

POS	Codice	U.M.	 Descrizione	 Description
RT5	RT000500	NR	TAPPO MASCHIO ESAGONO INTERNO GAS 3/8" SVASATO 60° *K*	MALE PLUG GAS INTERNAL HEX 3/8 "FLARE 60 ° * K *
RT6	RT000600	NR	TAPPO MASCHIO ESAGONO INTERNO GAS 1" SVASATO 60° *K*	MALE PLUG GAS INTERNAL HEX 1 "FLARE 60 ° * K *
RT7	RT000700	NR	TAPPO MASCHIO TE GAS 1/8" SVASATO 60° *K*	MALE PLUG TE GAS 1/8 "FLARE 60 ° * K *
RT8	RT000800	NR	TAPPO MASCHIO TE GAS 1/4" JIS	MALE PLUG TE GAS 1/4 " JIS
RT9	RT000900	NR	TAPPOO FEMMINA COMPLETO 6L	COMPLETE 6L FEMALE CAP
RT10	RT001000	NR	TAPPOO FEMMINA COMPLETO 8L	COMPLETE 8L FEMALE CAP
RT11	RT001100	NR	Tappo cilindrico TCEI+guarnizione GAS CI 5.8 3/4 Z.Bianca	cylindrical socket head cap + seal GAS CI 5.8 3/4 Z. White
RT12	RT001200	NR	Tappo cilindrico TCEI+guarnizione GAS CI 5.8 1/2 Z.Bianca	cylindrical socket head cap + seal GAS CI 5.8 1/2 Z. White
RV1	RV000100	NR	VITE PER OCCHIO GAS 1/4" H=29 *K*	SCREW EYE FOR GAS 1/4 "H = 29 * K *
RV2	RV000200	NR	VITE PER OCCHIO DOPPIA GAS 3/8"	SCREW EYE DOUBLE FOR GAS 3/8 "
RV3	RV000300	NR	VITE PER OCCHIO GAS 1/2" H= 50	SCREW EYE FOR GAS 1/2 "H = 50
RV4	RV000400	NR	VITE PER OCCHIO DOPPIA GAS 1/4"	DOUBLE EYE SCREW FOR GAS 1/4"
RV5	RV000500	NR	VITE PER OCCHIO GAS 3/8"	SCREW EYE FOR GAS 3/8"
RV6	RV000600	NR	VITE PER OCCHIO GAS 1/8"	SCREW EYE FOR GAS 1/8"

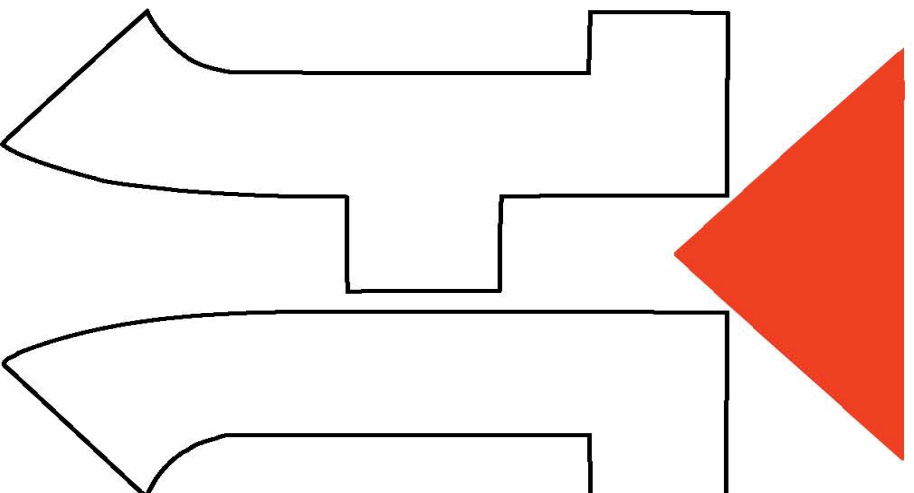

HINOWA SPA.
Via Fontana 37054 NOGARA (VR) - Italy
Tel. +39 0442 539100 Fax +39 0442 539075
E-mail: hinowa@hinowa.it Web site: www.hinowa.com
Marketing: info@hinowa.com